

A Power Quality analyser and fault recorder

Model PQI-DE

- ▶ 4 x voltage, 5 x current
- ▶ 20 kHz bandwidth
- ▶ Residual current monitor RCM



1. Application

The Power Quality Analyser and Fault Recorder PQI-DE for low, medium and high voltage networks is the central component of a system with which all measurement tasks in electrical networks can be solved.

The PQI-DE can be used as a Power Quality Interface according to power quality standards such as IEC 61000-2-2 / EN 50160 or to check the technical connection guidelines such as DIN VDE AR 4110 and DIN VDE 4120 and many more. Due to the available open SCADA standard interfaces such as Modbus RTU/TCP as well as IEC 61850 with open data exchange format PQDIF (IEEE1159-3), the device can also be used as a highly accurate measurement transducer for all physically defined measured variables in 3-phase systems parallel to the continuous recording of measured values over a very long period.

In addition to the possibility of standard evaluations, the PQI-DE also has a high-speed disturbance recorder with a recording rate of 40.96kHz/10.24kHz and a 10ms TRMS effective value recorder. This allows a detailed evaluation of grid disturbances.

The PQI-DE is equipped with a fifth current input for continuous residual current monitoring (RCM). It is possible to freely program thresholds for alarms or warnings.

Modern Power Quality Analysers comply with the IEC 62586 standard, which describes the complete product feature of a Power Quality Analyser. This standard defines not only the purpose of use, the EMC environment and the environmental conditions, but also the exact measurement methods IEC 61000-4-30 Class A, in order to create a comparable and reliable basis for the end-user.

Devices from different manufacturers that work according to this standard must provide the same measurement results.

According to IEC 62586, the PQI-DE is a device of class **PQI-A-FI-H** and is therefore fully certified in external laboratories.

Power Quality Interface – Class A – Fixed Installed Measurement Device for Indoor operation in Harsh EMC environments

The PQI-DE meets the requirements of IEC 61000-4-30:2015 Ed 3 +A1:2021 for Class A measuring instruments for 100 % of the parameters.

Parameter IEC61000-4-30 Ed. 3	Class
Power frequency	A
Magnitude of the Supply Voltage	A
Flicker	A
Supply voltage dips and swells	A
Voltage interruptions	A
Supply voltage unbalance	A
Voltage harmonics	A
Voltage interharmonics	A
Mains signalling voltage	A
Measurement aggregation intervals	A
Time-clock uncertainty	A
Flagging	A
Transient influence quantities	A

2. Design

The *PQI-DE* has been developed for measurements performed within public grids as well as for recording PQ data within an industrial environment up to 690V (L-L) measurement voltage.

- No moving parts (fans, hard drives etc.)
- CAT IV
- Extensive storage capability (can be extended up to 32 GB by the user, permitting several years recording without connection to database)
- ▶ **Optional: "IEC 61000-4-7 - 2 kHz to 9 kHz" (B1)**
- Frequency measurement of voltage and current according IEC 61000-4-7 from 2 kHz to 9 kHz.
- Sampling rate voltage and current 40.96kHz
- ▶ **Optional: Residual current monitor RCM (D1)**
- ▶ **Optional: "PQDIF data format" (F1)**
- Open data exchange format according to IEEE1159-3 via MMS / IEC61850 (feature P2)

2.1 Characteristics of the Power-Quality Interface *PQI-DE*

2.1.1 Technical Data

- 5-inch colour display
- Keypad for basic/direct device configuration
- 1 GB internal memory (extended up to 32 GB)
- IP54 in installed condition
- Input channel bandwidth 20 kHz (voltage and current)
- 4 voltage inputs Accuracy < 0.1 %
- 4 current inputs
- 5. current input for the detection of differential currents or currents of the ZEP (central grounding point) (Firmware version 2.2)
- Temperature input for Pt100 and Pt1000 sensor
- Simultaneous processing of sampled and calculated voltages and currents
- Oscilloscopic voltage and current recorder sampling rate : 40.96 kHz / 10.24 kHz
- Half cycle recorder : power frequency, RMS of voltages and currents, voltage and current phasors, power recording rate : ~10 ms(50 Hz) / ~8.33 ms (60 Hz)
- Powerful recorder triggering
- Online streaming of voltages and currents at 40.96 kHz sampling rate.

- Recording of power quality incidents according to DIN EN 50160; IEC 61000-2-2; -2-12; -2-4
- Power buffer for voltage interruptions of up to 2 seconds
- Spectral analysis 2 kHz...9 kHz (35 frequency bands, Bandwidth = 200Hz) of voltages and currents according (IEC 61000-4-7)
- Phase of voltage and current harmonics n=2..50
- 8 general purpose digital inputs (Triggering fault records, Recording Start / Stop, General documentation of external level)
- 4 relay outputs for protection monitoring and alarm
- Free of charge analysis software WinPQ Lite (sold as a package)
- **Option:** Analysis of the data on a database using the WinPQ software package.

Permanent communication and evaluation of the data with many devices in parallel.

Communication Protocols

- MODBUS RTU & MODBUS TCP
- IEC 60870-5-104 (Option P1)
- IEC 61850 (Option P2)

Time synchronisation protocols

- IEEE 1344 / IRIG-B000...007
- GPS (NMEA +PPS)
- DCF77
- NTP

Interfaces

Ethernet	RJ45 (10/100 Mbit)
USB	USB 2.0 – Type C
Two RS232/RS485	switchable

Dimensions

L x B x H	144 x 144 x 90 mm without terminals
Outbreak size:	144 x 150 x 110mm with terminals 138 x 138 mm (+0.8 mm)
Weight	1220 g

Voltage inputs			
Feature	E1	E2	E3
Channels	U ₁ , U ₂ , U ₃ , U _{N/E/4}		
Electrical safety DIN EN 61010	150V CATII	300V CAT IV 600V CAT III	SELV
Input reference level	PE	PE	PE
Impedance -> PE	2 MΩ 25pF	10 MΩ 25pF	2 MΩ 25pF
Nominal input voltage Un	100 V _{AC}	230 V _{AC}	3,25 V _{AC}
Full scale range (FSR)	0...120 V _{AC} L-E	0...480 V _{AC} L-E	0...5 V _{AC} L-E
Waveform	Any AC / DC	Any AC / DC	Any AC / DC
Maximum crest factor @ Un	3		
Bandwidth	DC...20 kHz		
Nominal power frequency fn	50 Hz / 60 Hz		
Frequency range of the fundamental	fn ± 15 % 42.5..50..57.5 Hz 51.0..60..69.0 Hz		

Accuracy

Fundamental, r.m.s	±0.1 % Un (0°C...45°C) ±0.2 % Un (-25°C...55°C) @ 10 %...150 % Un
Fundamental, Phase	±0.01° @ 10%...150%Un
Harmonics n = 2..50, r.m.s.	±5 % of reading @ U _h ≥ 1 % Un ±0.05 % Un @ U _h < 1 % Un
Harmonics n = 2..50, Phase	±n·0.01° @ U _h ≥ 1% Un
Interharmonics n = 1..49, RMS	±5 % of reading @ U _{ih} = ≥ 1% Un ±0.05 % Un @ U _{ih} < 1% Un
Power frequency	±1mHz @ 10%...200%Un
Flicker	Class F2

Voltage inputs			
Feature	E1	E2	E3
DIN EN 61000-4-15:2011			
Dip residual voltage			±0.2 % Un @ 10%..100%Un
Dip duration			±20 ms @ 10 %..100 % Un
Swell residual voltage			±0.2% Un @ 100 %..150 % Un
Swell duration			±20 ms @ 100 %..150 % Un
Interruption duration			±20 ms @ 1 %..100 % Un
Voltage unbalance			±0.15 % @ 1 %..5 % reading
Mains signalling voltage (< 3 kHz)			±5 % of reading @ U _s = 3 %..15 % Un ±0.15 % Un @ U _s = 1 %..3 % Un

We take care of it.

Current inputs		
Feature	C30	C31
Channels	I1, I2, I3, IN/4	
Electrical safety DIN EN 61010	300V CAT III	
Input type	Differential, isolated	
Impedance	≤ 4 mΩ	
Nominal input current I _n	1 A _{AC} /5 A _{AC}	
Full scale range (FSR)	10 A _{AC}	100 A _{AC}
Overload capacity permanent	20 A	
≤ 10s	100 A	
≤ 1s	500 A	
Waveform	AC, any	
Maximum crest factor @ I _n	4	
Bandwidth	25 Hz...20 kHz	
Tightening torque	2 Nm	

Accuracy

Fundamental, RMS	< 0,1 % FSR 5 %...100 %	< 0,2% FSR 5 % ... 10 %
Fundamental, Phase	±0,1° 5 %...100 %	±0,2° 5 % ... 10 %
Harmonics n = 2..50, r.m.s.	5 % 5 %...100 %	10 % 5 % ... 10 %
Harmonics n = 2..50, Phase	±n·0,1° 5 %...100 %	±n·0,2° 5 % ... 10 %
Interharmonics n = 1..49, r.m.s.	±5 % 5 %...100 %	±10 % 5 % ... 10 %

Current inputs (Rogowski coil) – Feature C40	
Option	C40
Channels	I1, I2, I3, IN/4
Impedance	1 MΩ
Input range	0.35 V _{AC}
Bandwidth	DC...20 kHz
AC Requirements	galvanic isolated

Current inputs (current clamps) - Feature C44/45		
Feature	C44	C45
Channels	I1, I2, I3, IN/4	
Impedance	1MΩ	1MΩ
Input range	0.5 V _{AC}	4 V _{DC}
Bandwidth	DC...20kHz	
AC Requirements	galvanic isolated	

Power supply			
Feature	H1	H2	H3
AC Nominal range [V]	100...240	-	-
AC Operating range [V]	90...264	-	-
DC Nominal range [V]	120...320	24...60	48...138
DC Operating range [V]	108...350	18...75	40...160
Power consumption	≤ 10 W < 20 VA	≤ 10 W	≤ 10 W
Frequency Nominal	50...60Hz	DC	DC
Frequency Operating	40...70Hz	DC	DC
External fuse characteristics	6A B	6A B	6A B
Energy storage	2 sec	2 sec	2 sec

Storage of measured values	
Internal memory	1024 MB
SD memory card	1 GB to 32 GB

Binary outputs (BO)	
4 binary outputs	3 x closer 1 x changeover
Contact specification (EN60947-4-1, -5-1) : Configuration Nominal voltage Nominal current Nominal load AC1 Nominal load AC15, 230VAC Interrupting power DC1, 30/110/220 V	3 x SPST (Single Pole Single Throw) 1 x SPDT (Single Pole Double Throw) 250VAC 6 A 1500 VA 300 VA 6/0.2/0.12 A
Number of switching operations AC1	≥ 60·10 ³ electrical
Electrical isolation	Isolated from all internal potentials
Electrical safety DIN EN 61010	300V

Binary inputs (BI)		
Feature	M1	M2
8 binary inputs	0 V...250 V _{AC}	0 V...48 V _{DC}
Range	/√ _{DC}	
<ul style="list-style-type: none"> — H – Level — L – Level 	> 35 V < 20 V	> 10V < 5V
Signal frequency	DC ... 70 Hz	DC ... 70 Hz
Input resistance	> 100 kΩ	6.8 kΩ
Electrical isolation	Optocoupler, electrically isolated	
Electrical safety DIN EN 61010	300V	

Residual current monitor (RCM) – (Firmware V2.2)	
Nominal current	30 mA
Impedance	4 Ω
Overload capacity	5 A (1 seconds)
Resolution	24bit-ADC

Temperature input Pt 100 / Pt 1000 / KTY- (Firmware V2.2)	
Contacting measurement sensor (software setting)	2 wire
	3 wire
	4 wire
Update rate	1 second / 1Hz
Resolution	15 Bit
Burden	1,9 kOhm
Accuracy	0.05 % FSR

Electromagnetic Compatibility
Immunity <ul style="list-style-type: none"> IEC 61000-6-5, environment H
Emissions <ul style="list-style-type: none"> CISPR22 (EN 55022) , class A

Electrical safety	
<ul style="list-style-type: none"> IEC 61010-1 IEC 61010-2-030 	
Protection class	1
Pollution degree	2
Overvoltage category mains supply option : H1 H2/H3	300V CAT II 150V CAT II
Measurement category	300V CAT IV 600V CAT III
Altitude	≤ 2000 m
IP protection class	IP54 (in installed condition)

Environmental parameters	Storage and transport	Operation
Ambient temperature : Limit range of operation	IEC 60721-3-1 / 1K5 -40 ... +70°C IEC 60721-3-2 / 2K4 -40 ... +70°C	IEC 61010 -25 ... +45°C H1 -25 ... +50°C H2/H3
Ambient temperature : Rated range of operation H1 Rated range of operation H2 /H3	---	IEC DIN EN 61010 -25 ... +45°C -25 ... +50°C
Relative humidity: 24h average No condensation or ice	5...95 %	5...95 %
Solar radiations	---	700 W/m ²
Vibration, earth tremors	IEC 60721-3-1 / 1M1 IEC 60721-3-2 / 2M1	IEC 60721-3-3 / 3M1

2.1.2 Mechanical design

The PQI-DE is used as a panel-mounted device and fulfils IP54 when installed. All connections are accessible via Phoenix terminals. With the exception of the current inputs, the connections are made using plug-in terminal technology.

A TCP/IP interface (RJ 45 LAN connection) and a USB interface (type C socket) are available for communication. In addition to the internal memory of 1 GB, the device memory can be expanded by a further 32 GB via an external memory card. The memory card can also be used to easily read out measurement data from the instrument and transmit it to an evaluation PC.

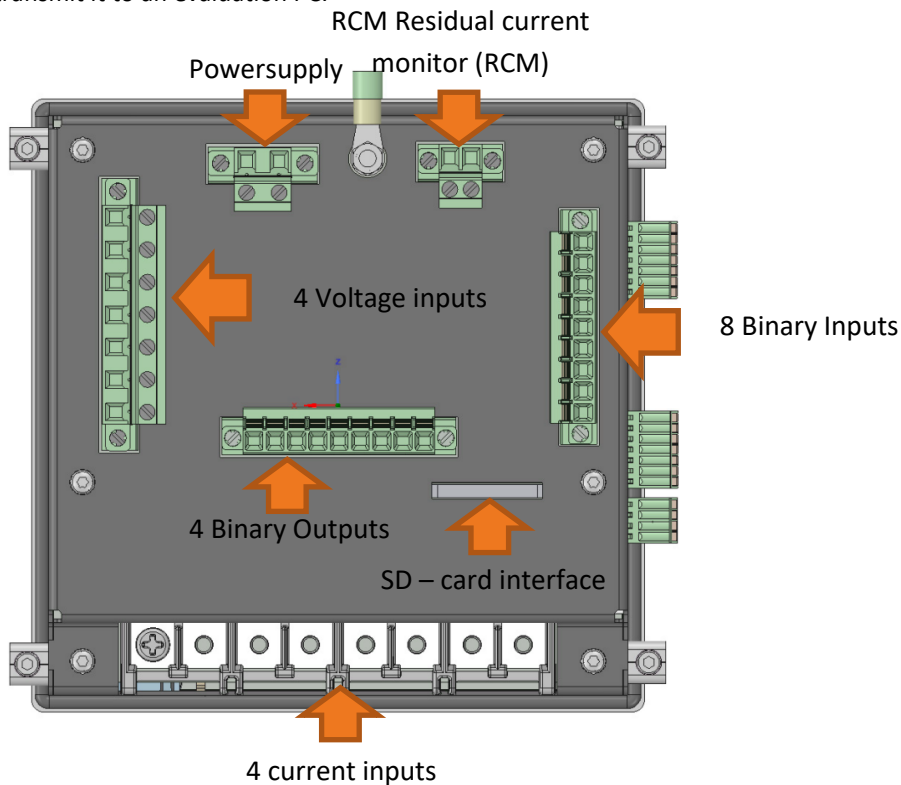

Back view PQI-DE

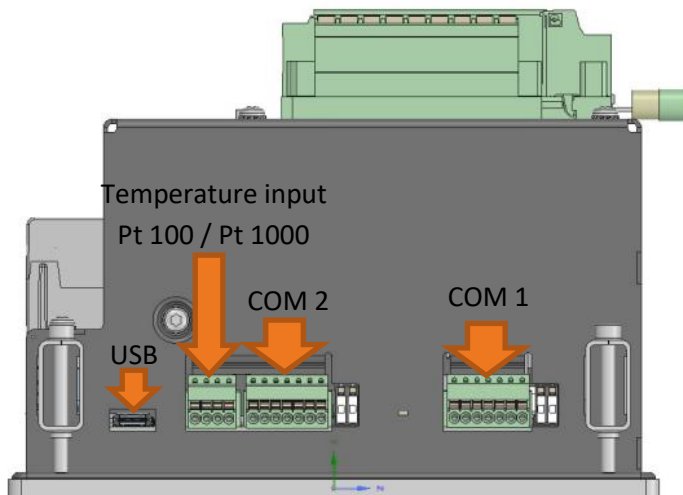

Side view of PQI-DE

2.1.3 Terminal strip number PQI-DE

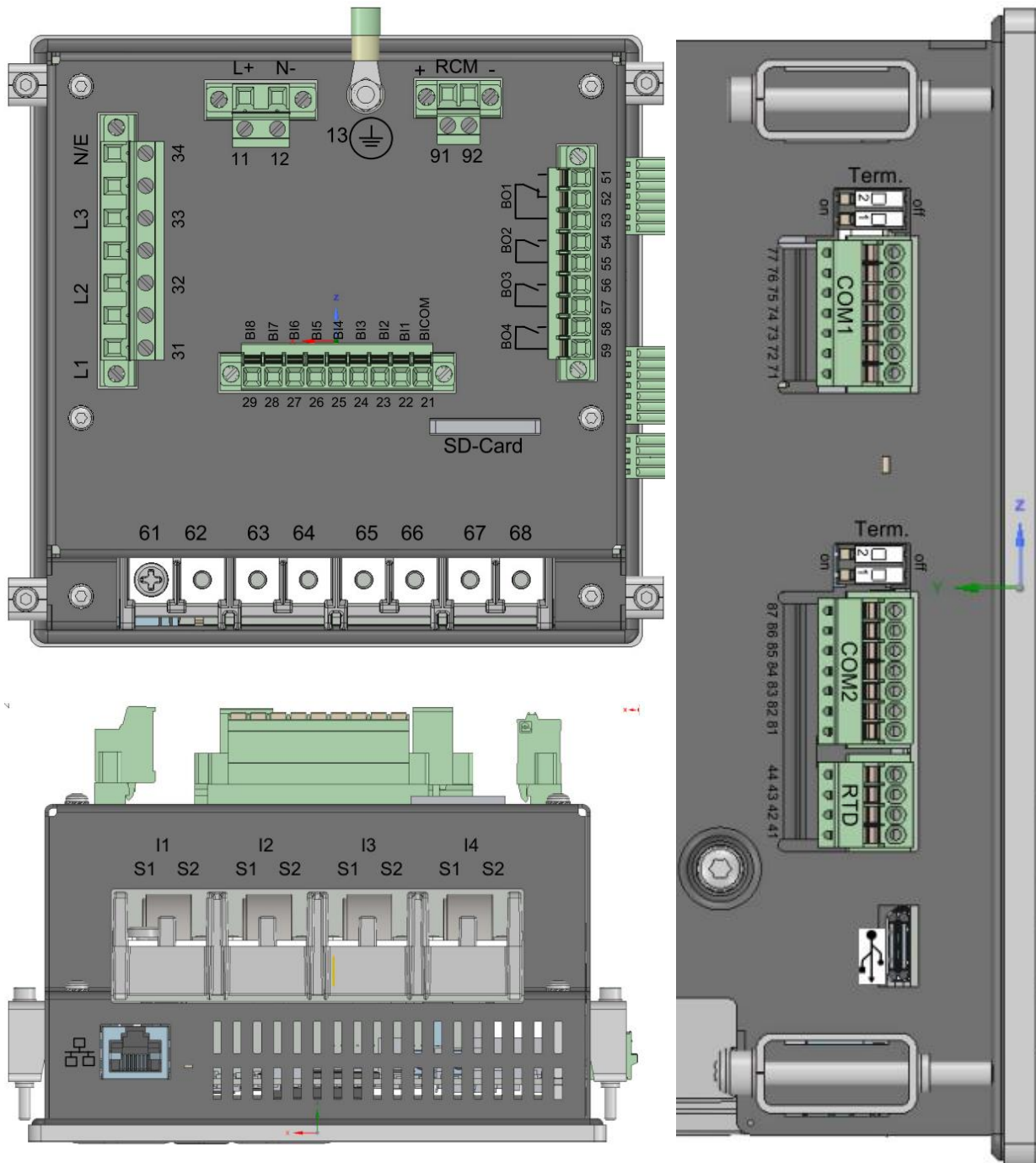

Terminal strip no.	Designation	Function	Terminal no.	cross section [mm ²]	Stripping length mm	Torque in Nm	
X1	Auxiliary voltage	U _H	L (+)	11	0.2 ... 2.5	10	0,5 ... 0,6
			L (-)	12	0.2 ... 2.5	10	0.5 ... 0.6
X1	Ground	GND	PE	13	ring terminals M4	-	0.5 ... 0.6

Terminal strip no.	Designation	Function	Terminal no.	cross section [mm ²]	Stripping length mm	Torque in Nm	
X2	Binary input	BICOM	-	21	solid: 0.2 ... 1.5 flexible: 0.2 ... 2.5	10	0.5 ... 0.6
		BI1	+	22		10	0.5 ... 0.6
		BI2	+	23		10	0.5 ... 0.6
		BI3	+	24		10	0.5 ... 0.6
		BI4	+	25		10	0.5 ... 0.6
		BI5	+	26		10	0.5 ... 0.6
		BI6	+	27		10	0.5 ... 0.6
		BI7	+	28		10	0.5 ... 0.6
X3	Phase voltage L1 (AC)	U ₁	L1	0.2 ... 2.5	10	0.5 ... 0.6	
	Phase voltage L2 (AC)	U ₂	L2		10	0.5 ... 0.6	
	Phase voltage L3 (AC)	U ₃	L3		10	0.5 ... 0.6	
	Neutral point voltage (AC)	U ₄	N/E		10	0.5 ... 0.6	
X4	PT100/Pt1000/KTY Temperature input	T1	RTDOU+	41	0.14 ... 0.5	10	0.5 ... 0.6
			RTDIN+	42		10	0.5 ... 0.6
			RTDIN-	43		10	0.5 ... 0.6
			RTDOU-	44		10	0.5 ... 0.6
X5	Binary output	R1	NO	51	solid: 0.2 ... 1.5 flexible: 0.2 ... 2.5	10	0.5 ... 0.6
			NC	52		10	0.5 ... 0.6
			Pol	53		10	0.5 ... 0.6
		R2	NO (+)	54		10	0.5 ... 0.6
			Pol (-)	55		10	0.5 ... 0.6
		R3	NO (+)	56		10	0.5 ... 0.6
			Pol (-)	57		10	0.5 ... 0.6
		R4	NO (+)	58		10	0.5 ... 0.6
Pol (-)	59		10	0.5 ... 0.6			
X6	Phase current L1	I1	S1 (K) S2 (L)	1.5 – 4 mm ²		0.5 ... 0.8	
	Phase current L2	I2	S1 (K) S2 (L)			0.5 ... 0.8	
	Phase current L3	I3	S1 (K) S2 (L)			0.5 ... 0.8	
	Neutral / sum current	I4	S1 (K) S2 (L)			0.5 ... 0.8	
X9	RCM - Input	I5	+	91	solid: 0.34... 2.5 flexible: 0.2 ... 2.5	10	0.5 ... 0.6
			-	92		10	0.5 ... 0.6

2.1.4 Dimensions

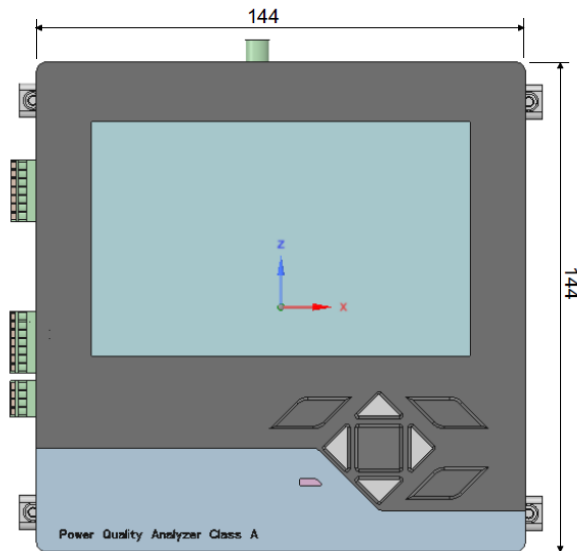

Front view PQI-DE

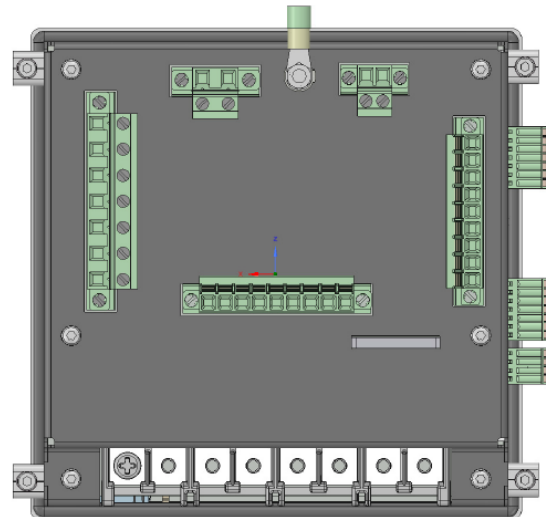

Back View PQI-DE

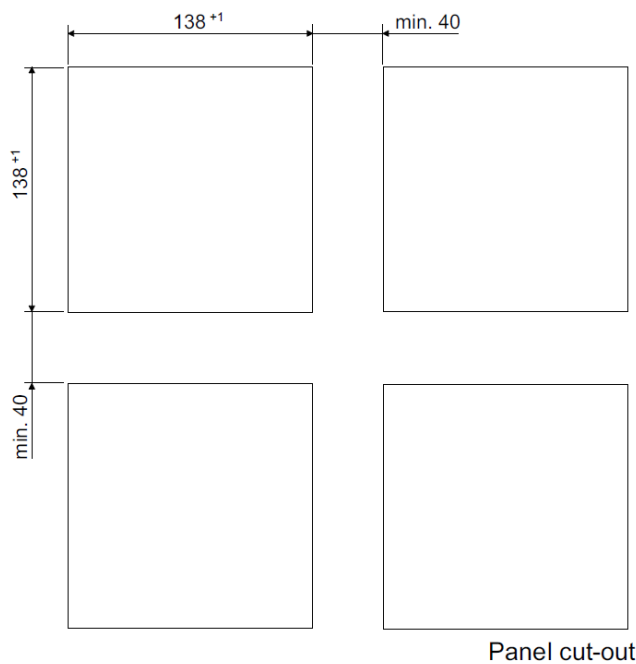

Panel cut-out PQI-DE

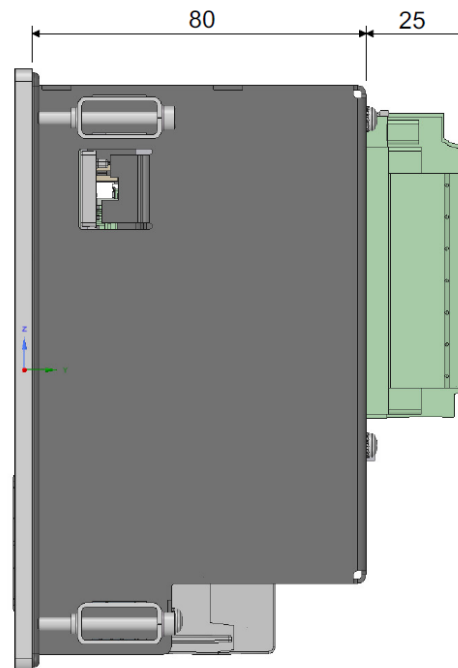

Right view PQI-DE

The maximum panel thickness for PQI-DE installation is 8mm.

2.1.5 Colour display

The device's 5-inch colour display provides information about the correct connection of the measuring cables and transmitter and shows online data of voltage, current, total harmonic distortion (THD), harmonics up to 9 kHz power and energy. A kind of drag pointer function informs about the maximum current of the last day, the last week, the last month and absolute since the last reset of the extreme value.

The number of Power Quality events, oscilloscope and RMS fault records for the last day, week and month appear on the display.

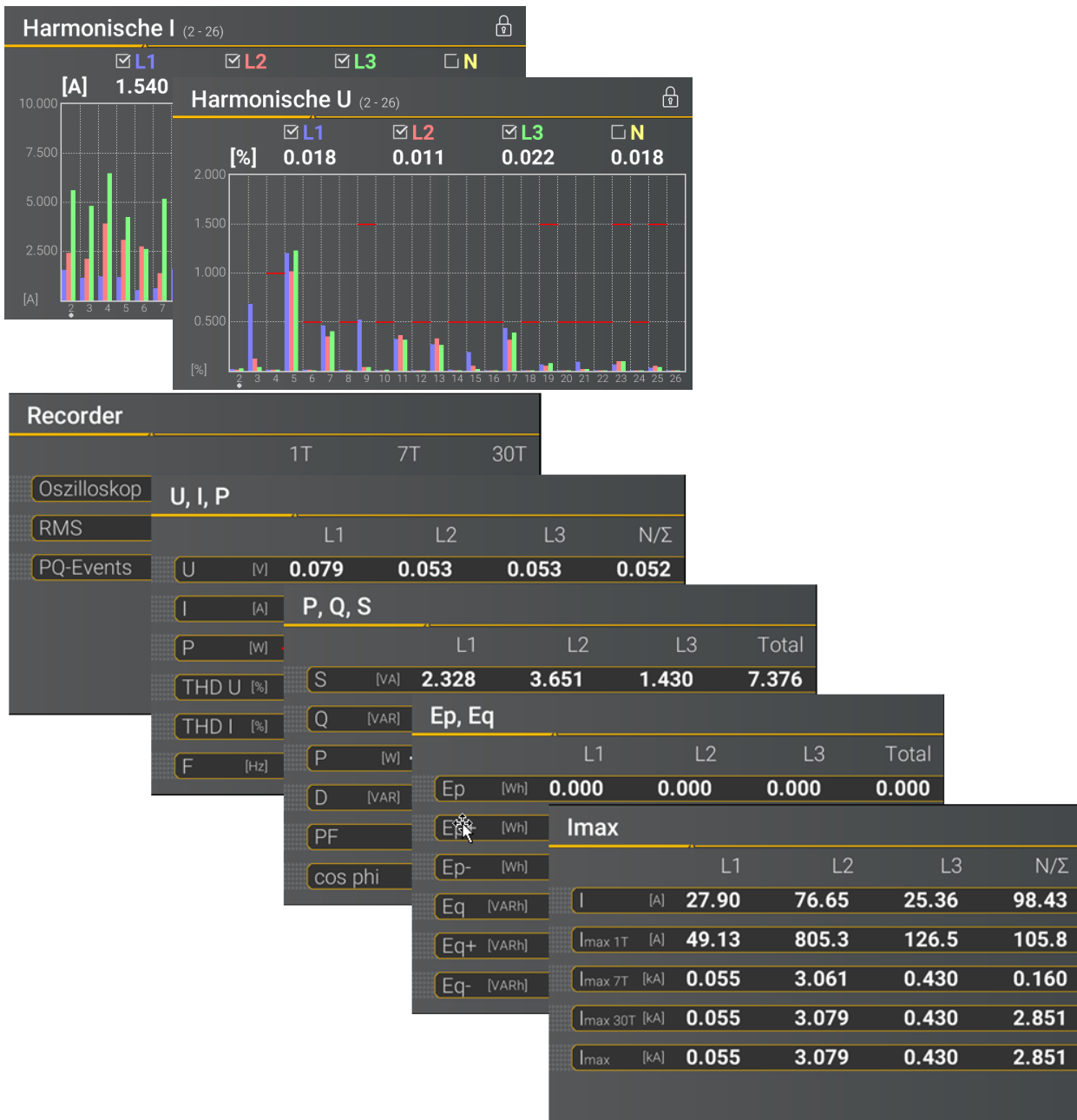

The commissioning and parameterisation of the PQI-DE can be carried out very easily via the keypad and the display of the device or via the WinPQ Lite software.

2.2 Measurement / Functions

PQI-DE complies with the automatic event detection and measurement standards, which are:

EN50160:2021/ IEC61000-2-2 / IEC61000-2-12 /IEC61000-2-4 (Class 1; 2; 3) / NRS048 / IEEE519 / IEC61000-4-30 Class A Ed 3/ IEC 61000-4-7 / IEC61000-4-15 / IEEE1159-3

Continuous Recording:

Five fixed and two variable measurement time intervals are available for continuous recording:

10/12 T (200ms), 1 sec, n*sec, 150/180 T (3sec), n*min, 10 min, 2 h

Time Interval Voltage	10/ 12T	150/ 180T	10 min	2 h	1 s	10s	N* s	N* min
PQDIF			✓	✓		✓		
Power frequency	✓	✓	✓	✓	✓	✓	✓	✓
Extremes, standard deviation of power frequency (10s)			✓			✓		
r.m.s. values (IEC61000-4-30)	✓	✓	✓	✓	✓		✓	✓
Extremes, standard deviation of T/2-values			✓					
Underdeviation [%] , Overdeviation [%] (IEC61000-4-30)	✓	✓	✓	✓				
Harmonic subgroups n= 0..50 (IEC61000-4-7)	✓	✓	✓	✓				
Maximum values of 10/12 T harmonic subgroups n = 2..50			✓					
Interharmonic subgroups n=0..49 (IEC61000-4-7)	✓	✓	✓	✓				
Total Harmonic Distortion (THDS) (IEC61000-4-7)	✓	✓	✓	✓	✓		✓	✓
Partial Weighted Harmonic Distortion (PWHD)	✓	✓	✓	✓	✓		✓	✓
Unbalance, negative-/positive- sequence , sequence sign	✓	✓	✓	✓	✓		✓	✓
Unbalance, zero-/positive- sequence	✓	✓	✓	✓	✓		✓	✓
Positive-, negative-, zero sequence phasors	✓	✓	✓	✓	✓		✓	✓
Phasors (fundamental)	✓	✓	✓	✓	✓		✓	✓
Flicker (IEC61000-4-15)			✓	✓				
Instant flicker (IEC61000-4-15)	✓		✓					
Mains signalling voltages [%] (IEC61000-4-30)	✓	✓						
Phase angle(zero crossings) of phase voltage harmonics n=2..50 to fundamental of reference voltage	✓	✓	✓	✓				
Frequency bands 1..35 , 2kHz..9kHz, r.m.s. (IEC61000-4-7)			✓	✓	✓		✓	✓

Time Interval Current	10/ 12T	150 /180T	10 min	2 h	1 s	N* s	N* min
PQDIF			✓	✓			
r.m.s. values	✓	✓	✓	✓	✓	✓	✓
Extremes of T/2-values			✓				
Harmonic subgroups n= 0..50 (IEC61000-4-7)	✓	✓	✓	✓			
Maximum values of 10/12 T harmonic subgroups n = 2..50			✓				
Interharmonic subgroups n=0..49 (IEC61000-4-7)	✓	✓	✓	✓			
Total Harmonic Distortion (THDS) (IEC61000-4-7)	✓	✓	✓	✓	✓	✓	✓
Total Harmonic Currents	✓	✓	✓	✓	✓	✓	✓
Partial Weighted Harmonic Distortion (PWHD)	✓	✓	✓	✓	✓	✓	✓
Partial Odd Harmonic Currents (PHC)	✓	✓	✓	✓	✓	✓	✓
K-Factors	✓	✓	✓	✓	✓	✓	✓
Unbalance, negative-/positive- sequence , sequence sign	✓	✓	✓	✓	✓	✓	✓
Unbalance, zero-/positive- sequence	✓	✓	✓	✓	✓	✓	✓
Positive-, negative-, zero sequence phasors	✓	✓	✓	✓	✓	✓	✓
Phasors (fundamental)	✓	✓	✓	✓	✓	✓	✓
Phase angle(zero crossings) of current harmonics n=2..50 to fundamental of reference voltage	✓	✓	✓	✓			
Frequency bands 1..35 , 2kHz..9kHz, r.m.s. (IEC61000-4-7)			✓	✓	✓	✓	✓

Time Interval Energy	10 min	2 h	1 s	N* s	N* min
PQDIF	✓	✓			
Active energy, phase	✓	✓	✓	✓	✓
Active energy, total	✓	✓	✓	✓	✓
Exported active energy, phase	✓	✓	✓	✓	✓
Exported active energy, total	✓	✓	✓	✓	✓
Imported active energy, phase	✓	✓	✓	✓	✓
Imported active energy, total	✓	✓	✓	✓	✓
Reactive energy (inductive), phase	✓	✓	✓	✓	✓
Reactive energy (inductive), total	✓	✓	✓	✓	✓
Exported reactive energy (inductive), phase	✓	✓	✓	✓	✓
Exported reactive energy (inductive), total	✓	✓	✓	✓	✓
Imported reactive energy (inductive), phase	✓	✓	✓	✓	✓
Imported reactive energy (inductive), total	✓	✓	✓	✓	✓
Total apparent energies, phase& total	✓	✓	✓	✓	✓
Export apparent energies, phase & total	✓	✓	✓	✓	✓
Import apparent energies, phase & total	✓	✓	✓	✓	✓
Distortion reactive energies, phase & total	✓	✓	✓	✓	✓

Time Interval Power	10 min	2 h	1 s	N* s	N* min					
Active power, phase	✓	✓	✓	✓	✓					
Active power, total	✓	✓	✓	✓	✓					
Active power extremes	✓									
Reactive power, phase	✓	✓	✓	✓	✓					
Reactive power, total	✓	✓	✓	✓	✓					
Reactive power extremes	✓									
Apparent power, phase	✓	✓	✓	✓	✓					
Apparent power, total	✓	✓	✓	✓	✓					
Fundamental active power, phase	✓	✓	✓	✓	✓					
Fundamental active power, total	✓	✓	✓	✓	✓					
Fundamental reactive power, phase	✓	✓	✓	✓	✓					
Fundamental reactive power (displacement), total	✓	✓	✓	✓	✓					
Fundamental apparent power, phase	✓	✓	✓	✓	✓					
Phase angle of fundamental apparent power, phase	✓	✓	✓	✓	✓					
Fundamental apparent power, total	✓	✓	✓	✓	✓					
Phase angle of fundamental apparent power, total	✓	✓	✓	✓	✓					
Reactive distortion power, phase	✓	✓	✓	✓	✓					
Reactive distortion power, total	✓	✓	✓	✓	✓					
Active power factors, phase, total	✓	✓	✓	✓	✓					
Reactive power factors, phase, total	✓	✓	✓	✓	✓					
COSφ + sign, phase, total	✓	✓	✓	✓	✓					
SINφ + sign, phase, total	✓	✓	✓	✓	✓					
COSφ + sign of reactive distortion power, phase, total	✓	✓	✓	✓	✓					
Capacitive-, inductive scaling factor of COSφ (-1..0..+1) :	✓	✓	✓	✓	✓					
Triggered interval mean active power, phase										
Triggered interval mean active power, total										
Triggered interval mean reactive power, phase										
Triggered interval mean reactive power, total										

Active power, phase	✓	✓	✓	✓	✓
Active power, total	✓	✓	✓	✓	✓
Active power extremes	✓				
Reactive power, phase	✓	✓	✓	✓	✓
Reactive power, total	✓	✓	✓	✓	✓
Reactive power extremes	✓				
Apparent power, phase	✓	✓	✓	✓	✓
Apparent power, total	✓	✓	✓	✓	✓
Fundamental active power, phase	✓	✓	✓	✓	✓
Fundamental active power, total	✓	✓	✓	✓	✓
Fundamental reactive power, phase	✓	✓	✓	✓	✓
Fundamental reactive power (displacement), total	✓	✓	✓	✓	✓
Fundamental apparent power, phase	✓	✓	✓	✓	✓
Phase angle of fundamental apparent power, phase	✓	✓	✓	✓	✓
Fundamental apparent power, total	✓	✓	✓	✓	✓
Phase angle of fundamental apparent power, total	✓	✓	✓	✓	✓
Reactive distortion power, phase	✓	✓	✓	✓	✓
Reactive distortion power, total	✓	✓	✓	✓	✓
Active power factors, phase, total	✓	✓	✓	✓	✓
Reactive power factors, phase, total	✓	✓	✓	✓	✓
COSφ + sign, phase, total	✓	✓	✓	✓	✓
SINφ + sign, phase, total	✓	✓	✓	✓	✓
COSφ + sign of reactive distortion power, phase, total	✓	✓	✓	✓	✓
Capacitive-, inductive scaling factor of COSφ (-1..0..+1) :	✓	✓	✓	✓	✓
tanφ (L+), Phase, total on imported inductive reactive energy	✓		✓	✓	✓
tanφ (C-),Phase, total on exported capacitive reactive energy	✓		✓	✓	✓
tanφ (L-),Phase, total on exported inductive reactive energy	✓		✓	✓	✓
tanφ (C+),Phase, total on imported capacitive reactive energy	✓		✓	✓	✓
Triggered interval mean active power, phase					
Triggered interval mean active power, total					
Triggered interval mean reactive power, phase					
Triggered interval mean reactive power, total					

Time interval temperature & RCM	10/ 12T	150/ 180T	10 min	2 h	1 s	N* s	N* min
Temperature					✓	✓	✓
Residual current RCM	✓	✓	✓	✓			
Residual current FCM	✓	✓	✓	✓			
Leakage conductances, capacitances	✓	✓	✓	✓			

2.3 Oscilloscopic recorder

Sampling rate: 40.96 kHz or 10.24 kHz
 Max. Record length: 4 s (40.96 kHz) or 16 s (10.24 kHz)

Quantities	
3-wire system	4-wire system
phase – ground voltages	phase –neutral voltages
residual voltage	neutral – ground voltage
phase – phase voltages	
phase currents	
total current	neutral current

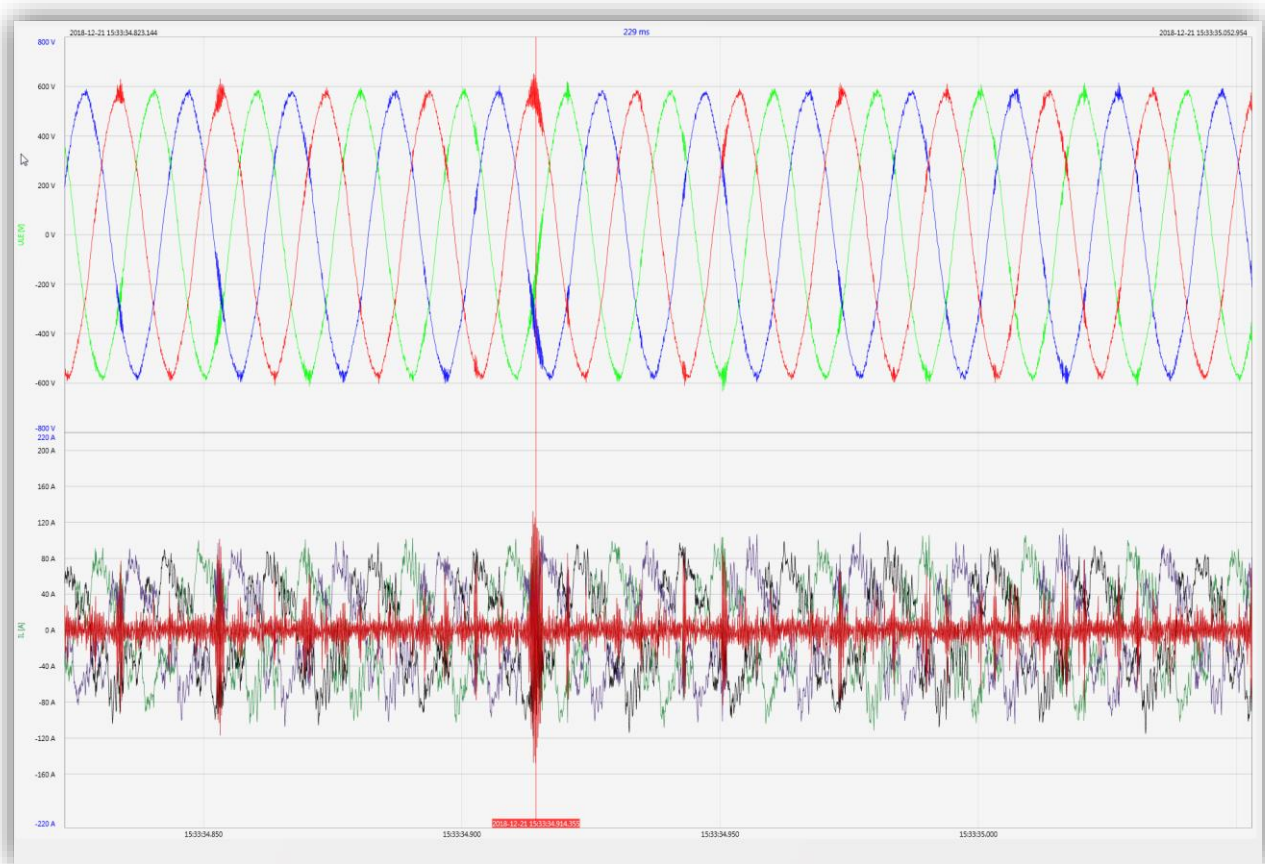

2.4 Half cycle recorder

Recording rate: ~10 ms (50 Hz) or ~8.333 ms (60 Hz)

Max. Record length: 6 min (50 Hz) or 5 min (60 Hz)

Quantities	
Power frequency	
r.m.s. voltages	
r.m.s. currents	
Active power, phase	
Reactive power, phase	
Active power, total	
Fundamental reactive power (displacement), total	
Phase angle of fundamental apparent power, total	
Voltage phasors (fundamental)	
Current phasors (fundamental)	
Positive-, negative-, zero sequence voltage phasors	
Positive-, negative-, zero sequence current phasors	

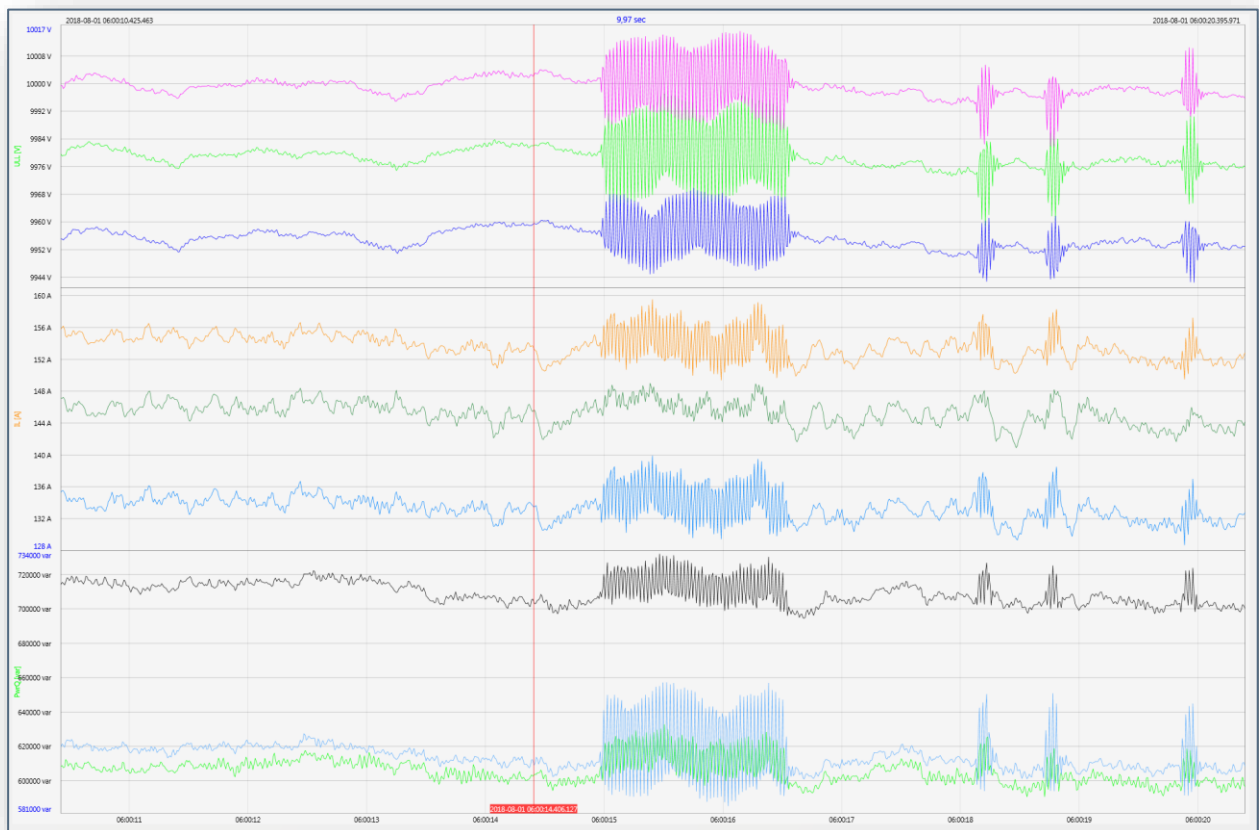

Very long recording of an grid fault with F, U, I, P and Q

2.5 Recorder triggering

trigger quantity	lower	upper	step
RMS phase voltages (T/2)	✓	✓	✓
RMS phase-phase voltages (T/2)	✓	✓	✓
RMS residual/neutral-ground voltage (T/2)		✓	✓
Positive sequence voltage (T/2)	✓	✓	
Negative sequence voltage (T/2)		✓	
Zero sequence voltage (T/2)		✓	
Phase voltage phase (T/2)			✓
phase voltages wave shapes (wave shape filter)	+/- threshold		
phase-phase voltages wave shapes (wave shape filter)			
residual/neutral-ground voltage wave shape (wave shape filter)			
RMS phase currents (T/2)	✓	✓	✓
RMS total / neutral current (T/2)		✓	✓
Power frequency (T/2)	✓	✓	✓
Binary inputs (debounced)	rising, falling slope		
Command	external		

2.6 PQ Events

trigger quantity	lower	upper
Voltage dip (T/2)	✓	
Voltage swell (T/2)		✓
Voltage interruption (T/2)	✓	
Voltage rapid voltage change (T/2)	sliding average filter mean +/- threshold	
Voltage change (10min)	✓	✓
Voltage unbalance (10min)		✓
Mains signalling voltage (150/180T)		✓
Voltage harmonics (10min)		✓
Voltage THD (10min)		✓
Voltage short term flicker PST (10min)		✓
Voltage long term flicker PLT (10min)		✓
Power frequency (10s)	✓	✓

2.7 Online mode for direct readings

Measurement / Functions

Oscilloscopic recorder

Voltage and current harmonics $n=2..50$

Voltage and current interharmonics $n=0..49$

Voltage and current harmonics 2-9kHz

Frequency spectra up to 20 kHz of voltages and currents

Online streaming of all data classes and all measured values

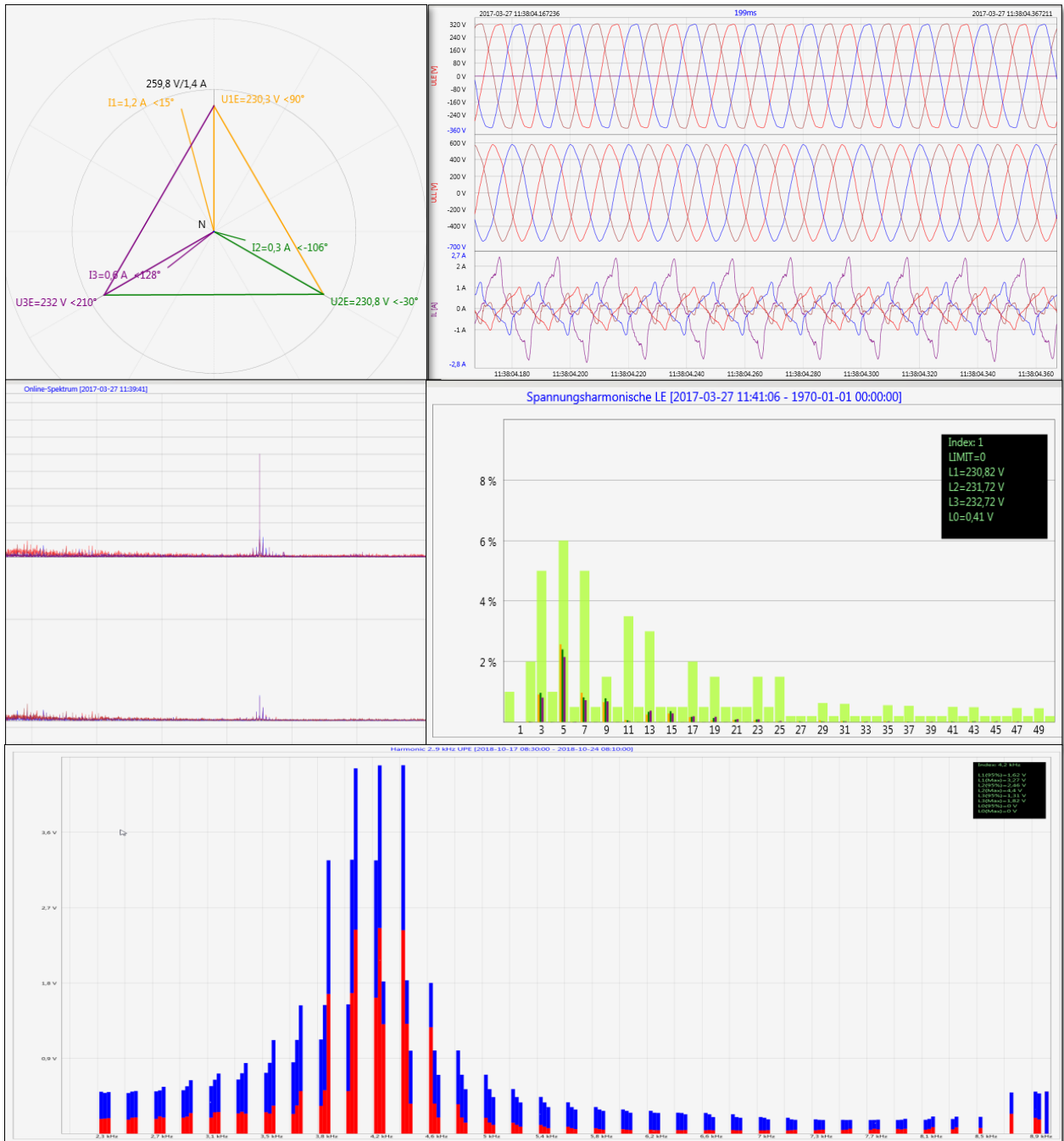

3. Order specifications *PQI-DE*

For determining the smart code ordering details:

- Only one unit can be ordered for codes with the same capital letter.
- When a code's capital letter is followed by the number 9, additional information in plain text is required.
- When a code's capital letter is followed only by zeros, the code may be omitted.

Characteristic	Code
Power Quality Interface and fault recorder <ul style="list-style-type: none"> ● 4 voltage converters, 4 current transformers ● In accordance with DIN EN 50160 and IEC 61000-4-30 (Class A) ● 8 digital inputs ● 4 relay outputs ● WinPQ Lite software for PQI-DE 	<i>PQI-DE</i>
Supply voltage (operation range) <ul style="list-style-type: none"> ● AC 90 V..110 V..264 V or DC 108 V..220 V..350 V ● DC 18 V...60 V...75 V ● DC 40 V...160V 	H1 H2 H3
Voltage inputs <ul style="list-style-type: none"> ● 100V 2MΩ 25pF (150V CATII) ● 100V / 400 V / 690V 10MΩ 25pF (300V CAT IV) ● 3,25V 2MΩ 50pF for small signal transducer IEC 61869-11 (SELV) 	E1 E2 E3
Current inputs <ul style="list-style-type: none"> ● 4 current inputs for metering circuit 1A/5A (range 10A) ● 4 current inputs for protection circuit 1A/5A (range 100A) ● 4 current inputs for Rogowski Coils (330mV input) ● 4 AC current inputs for current clamps (0,5V input AC converter) ● 4 DC current inputs for current clamps (5V input DC converter) 	C30 C31 C40 C44 C45
Binary inputs <ul style="list-style-type: none"> ● 8 programmable binary inputs (AC/DC 48..250V) ● 8 programmable binary inputs (DC 10..48V) 	M1 M2
Option IEC 61000-4-7 (40.96 kHz sampling) <ul style="list-style-type: none"> ● 10.24 kHz sampling; without 2 kHz to 9 kHz measurement ● Frequency measurement of voltage and current from 2 kHz to 9 kHz according IEC61000-4-7; 40.96 kHz sampling oscilloscope recorder 	B0 B1
Option RCM <ul style="list-style-type: none"> ● Without Residual current monitor RCM (5th current input) ● Residual current monitor RCM (5th current input) (Firmware V2.2) 	D0 D1
Option communication protocol <ul style="list-style-type: none"> ● Modbus RTU & TCP ● IEC 60870-5-104 (RJ45) ● IEC 61850 (RJ45) 	P0 P1 P2
Option Data format <ul style="list-style-type: none"> ● Without PQDIF export function according to IEEE1159-3 ● With PQDIF export function according to IEEE1159-3 Data transfer via feature P2 - IEC61850 / MMS 	F0 F1

Operating instructions <ul style="list-style-type: none"> ● German ● English 	G1 G2
--	----------

3.1 Option *PQI-DE*

Software WinPQ lite	Code
Software WinPQ lite For parameterising , as well as reading measurement data and online data as a single-user licence – free of charge	900.9086
Expansion WinPQ lite For recalibration of the PQI-DA smart and test report creation	900.9287
WinPQ database	Code
Software WinPQ For parameterization, archiving and evaluation of PQI-D, PQI-DA, PQI-DA smart and PQI-DE measurement data with the following basic functions: <ul style="list-style-type: none"> ● 32-bit/64-bit Windows program interface ● Database for saving the measured values per measuring point ● Data access via TCP/IP network ● Visualization option for all measured variables retrievable from a PQI-D, PQI-DA, PQI-DA smart and PQI-DE as a function of time and as a statistical variable ● Automatic reporting according to EN50160; IEC61000-2-2 / 2-4; IEEE519; etc. ● Automatic export functions (Comtrade, PQDif, ASCII, PDF) and fault report transmission ● One additional workstation license for one Windows user is included in the price 	WinPQ
Licences <ul style="list-style-type: none"> ● as single-user license for 2 PQ measuring instruments (PQI-D, PQI-DA, PQI-DA smart, PQI-DE) ● as single-user license for 2 to 10 PQ measuring instruments (PQI-D, PQI-DA, PQI-DA smart, PQI-DE) ● as single-user license for > 10 PQ measuring instruments (PQI-D, PQI-DA, PQI-DA smart, PQI-DE) ● as single-user license for > 100 PQ measuring instruments (PQI-D, PQI-DA, PQI-DA smart, PQI-DE) 	L0 L1 L2 L3
Operating instructions <ul style="list-style-type: none"> ● German ● English 	A1 A2

Additions to PQI-DE	Code
SD-memory card (external): 4 GByte industrial standard	900.9099.4
Radio time clock interface DFC 77	111.9024.01
GPS-Clock – Navilog Set - RS485 . DIN-Rail GPS receiver, GPS converter 5m connection cable, mounting bracket	111.7083
Power supply for Navilog (DIN rail power supply, 88-264VAC/24V, 10W)	111.7079
19" mounting frame - 6 HE - aluminium, anodised, dimensions: W x H:483x267 <ul style="list-style-type: none"> ● with one cut out (138 x 138 mm) for a PQI-DE ● with two cut-outs (138 x 138 mm) for two PQI-DE 	564.0144.01 564.0144.02

A. Eberle GmbH & Co. KG

Frankenstraße 160
D-90461 Nuremberg

Tel.: +49 (0) 911 / 62 81 08-0

Fax: +49-(0)911-62 81 08 99

E-mail: info@a-eberle.de

<http://www.a-eberle.de>

Presented by:

Copyright 2022 by A. Eberle GmbH & Co. KG

Subject to change without prior notice.

Version: 2/23/2022 10:32 AM