

SECULIFE | ST and SECULIFE | ST HV

Test Instruments for Portable Appliance Testing according to Health and Safety Policy and in Accordance with the Medical Product Law as well as for Routine Testing

3-349-448-03
19/2.13

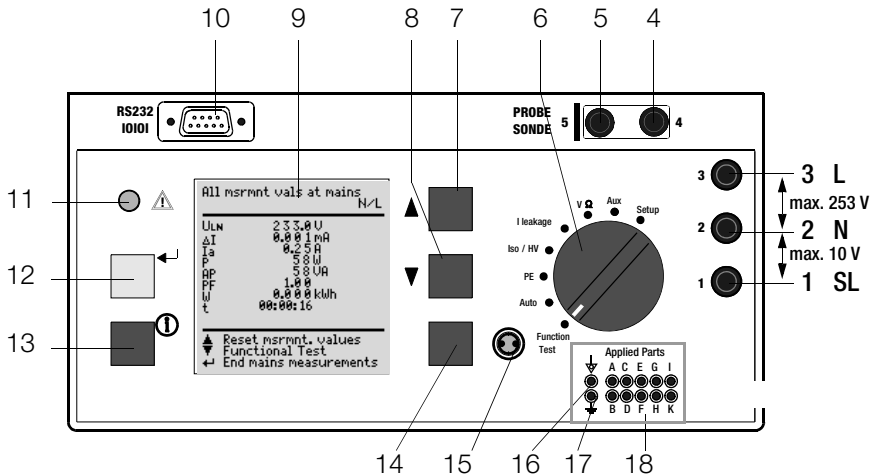



Probe connection

Insert the double plug of the probe into sockets 4 and 5 such that the plug with the white ring contacts socket 5 (vertical bar).

Note: Contact problems with exposed conductive parts when using the standard probe with test tip

In order to assure good contact, surface coatings must be removed from devices under test with special tools at a suitable location so that the surface has a metallic shine. The tip of the test probe is not suitable for scratching away paint, because this may impair its coating and/or mechanical strength. The brush probe (Z745G) may be more suitable than the test probe in certain individual cases.

Measurements at jacks 1 – 2 – 3

Always start with the measurement before contacting the measuring point. Between jacks 1 and 2, a maximum of 10 V may be applied. Between jacks 2 and 3, up to 253 V may be applied.



Attention: Jacks (2) and (3) are short-circuited during all measurements at the test socket! (Exception: see chapter 12.2)





Standard equipment

- 1 Test instrument with 10 + 2 connectors for application parts
- 1 Probe cable with test probe
- 1 Clip-on alligator clip for test probes
- 3 Clip-on quick-clamp terminals
- 10 conductor patient connection cable 2 mm
- 10 Clip-on alligator clip 2 mm
- 1 Calibration certificate per DAkkS
- 1 Operating instructions
- 1 Carrying strap

Up-to-date PC software (free start-up programs or demo software for data management, report and list generation) is available on our website for download.

These operating instructions describe an instrument with firmware version 7.35.



- 1 Jack for protective conductor at device under test
- 2 Jack for neutral conductor at device under test
- 3 Jack for phase conductor at device under test
- 4 Jack for connecting the probe
- 5 Jack for connecting the probe
- 6 Function selector switch
 - Function Test: Function test
 - Auto: Automatic test sequence according to selected standard
 - PE: Protective conductor test
 - Iso/HV: Insulation test / high-voltage test
 - I leakage: Leakage current measurement
 - V Ω : Multimeter functions
 - Aux: Auxiliary multimeter functions
 - Setup: Device configuration
- 7  scroll key for menu and parameter selection
- 8  scroll key for menu and parameter selection
- 9 LCD window
- 10 Socket connector interface RS232 for (P)SI module **SECUTEST PSI/SI+**, storage adapter **SECUSTORE**, barcode or RFID scanner
- 11 Signal lamp for mains connection error
- 12  key for entry and for starting test sequences and finger contact
- 13  help key (context sensitive)
- 14 Key next to the  symbol for switching test voltage to the test socket (only possible if symbol LED is blinking)
- 15 Signal lamp for the functions test
- 16 Functional earth (equipotential bonding)
- 17 Operational earth
- 18 Connector jacks for application parts
- 19 Push-buttons (left and right) for releasing the handle from its snap-in position
- 20 Earthing contact socket for service purposes (Feature B01), e.g. for connecting a notebook or an A4 format printer, Terminal Data see page 63
- 21 Standard outlet socket (test socket) for connecting the device under test
- 22 Push-buttons (left and right) for releasing the lid
- 23 Lid
- 24 Compartment for probe and accessories
- 25 Cover or (P)SI module (accessory **SECUTEST PSI** or **SECUTEST SI+**)
- 26 Carrying handle and tilt stand
- 27 Test probe (accessory probe with coil-cable SK2W (Z745N))

Overview of Available Probe Types

Probe Type	Application	Special Features
Standard probe (test probe with coil-cable and alligator clip)	Max. test current: 25 A	Probe with cable (no coil-cable)
SK2 ¹⁾	Max. test current: 25 A	Probe with cable (no coil-cable), 2 meters long
SK2W ¹⁾	Max. test current: 25 A	Probe with cable (coil-cable), 2 meters long
Feature KD01 with probe SK5	Restriction with Feature G01 ($I_K > 25$ A): short-circuit current < 25 A	Special probe in combination with "automatic recognition of measuring point change" function (see chapter 17)
Brush probe ¹⁾ Can be plugged onto all above listed probes and test probes	Leakage current, protective conductor resistance	For contacting devices under test with rotating, vibrating, exposed conductive parts

¹⁾ Accessory



Note

when using other probes than those specified above

The cables plugged into the sockets (4 and 5) must be short circuited for testing with the probe, i.e. by plugging the ends of the cable together, or via a conductive surface at the device under test (4-wire measurement).

Remove any corrosion from the device under test.



Data Security

Measurement data, report data and user entries are stored to RAM at the (P)SI module (accessory), as long as the respective battery supplies the required amount of voltage.

Save your data to a PC on a regular basis in order to prevent any loss of data at the (P)SI module. We assume no liability for data loss. We recommend the following PC programs for data processing and data management:

- **PS3** (transmission of measurement data to a PC, documentation, management, report generating and deadline follow-up)
- **PC.doc-WORD/EXCEL** (report and list generation)
- **PC.doc-ACCESS** (test data management)
- **ELEKTROmanager/PROTOKOLLmanager** for SECUTEST...
- **patManager** (Report and list generation)

Contents	Page	Contents	Page
1 Applications	6	8 Configuring Device Parameters	18
1.1 Table: Types of DUTs – Tests – Regulations	6	9 Measuring Protective Conductor Resistance	19
1.2 Table: Individual Measurements and Regulations	7	9.1 Maximum Allowable Limit Values for Protective Conductor Resistance for Connector Cables with a Length of up to 5 m	20
1.3 Table: Leakage Current Types	7	10 Insulation Measurement	20
1.4 List of Possible Options and Standard Types	8	10.1 Insulation Resistance R_{INS}	20
2 Safety Features and Precautions	9	10.2 Equivalent Leakage Current	22
2.1 Notes Regarding the High-Voltage Test (only Feature F02 or SECULIFE ST HV)	10	10.3 High-Voltage Test (Feature F02 or SECULIFE ST HV)	24
3 Initial Start-Up	11	11 Leakage Current Measurement	26
3.1 Connection to the Mains (115 V / 230 V, 50 Hz / 60 Hz)	11	11.1 Earth Leakage Current I_{PE} (Feature KA01)	26
3.2 Automatic Recognition of Mains Connection Errors	12	11.2 Contact Current	26
4 General Notes	12	11.3 Patient Leakage Current I_{PL}	27
4.1 Online Instructions	12	11.4 Patient Auxiliary Current I_{PA} (Feature KA01)	27
4.1.1 Changing the User Interface Language	12	11.5 Residual Current I_{RC}	27
4.1.2 Automatic Safety Class Selection	13	11.6 Device Leakage Current I_{LC} per IEC 62353 (VDE 0751-1)	27
4.1.3 Manual or Automatic Operating Sequences	13	12 Multimeter Functions	30
4.2 Online Help	13	12.1 Probe Voltage U_{probe} – Max. 300 V	30
4.3 Adjusting Contrast	13	12.2 Alternating / Direct Voltage $U_{AC/DC}$ – Max. 253 V	30
4.4 Configuring Device Parameters, Setting Date and Time	14	12.3 Resistance R	31
4.5 Configuring Measurement and Sequence Parameters	14	13 Measurements with Accessories	32
4.6 Setting Limit Values	14	13.1 Alternating Current I_{CLIP} with Clip-On Converter	32
4.7 Saving the Settings	14	13.2 Protective Conductor Resistance R_{PE} via Clip-On Meter	32
5 Classification of Devices Under Test	15	13.3 Temperature T with Pt100/1000 Sensor	33
5.1 Safety Classes	15	14 Function Test	34
5.2 Application Parts (electrical medical devices)	15		
6 Abbreviations	16		
7 Connecting the Device Under Test	17		

Contents	Page	Contents	Page
15		20	RS 232 Interface 64
	Measurements in Accordance with National and International Standards with Selector Switch in Auto Position ... 36	20.1	Transmission of Measurement Results to the (P)SI module 64
15.1	Test Sequences 36	20.2	PC Connection 64
15.2	Setting Up Test Sequences 37	20.2.1	Software Evaluation of Measurement Results 64
15.3	Configuring Measuring Parameters 39	20.2.2	Instrument Control via Interface Commands 64
15.4	Testing Devices in Accordance with DIN VDE 0701, Part 1 40	20.3	Interface Definition and Protocol 64
15.5	Testing Devices in Accordance with DIN VDE 0701, part 240 42		
15.6	Testing Devices in Accordance with DIN VDE 0701-0702:2008 44	21	Appendix 65
15.7	Testing Extension Cables for VDE 0701-0702 (VDE 0701 Part 1) (optional EL1 adapter) 46	21.1	Evaluation of Measured Values for Individual Measurements as well as for Calculated Quantities 65
15.8	Testing Multiple Outlets for VDE 0701-0702 (optional EL1 adapter) 47	21.2	Evaluation of Measured Values during Equivalent Leakage Current Measurement (Automatic Test Sequence According to Standard) 65
15.9	Testing in Accordance with DIN EN 60950 48	21.3	Index 66
15.10	Testing Devices in Accordance with EN 61010 50		
15.11	Testing Devices in Accordance with EN 60335 52	22	Maintenance - Recalibration 68
15.12	Testing in Accordance with IEC 62353/VDE 0751 54	22.1	Housing Maintenance 68
15.13	Testing in Accordance with EN 60601 (Feature KA01) 56	22.2	Recalibration 68
		22.3	Safety Checks 68
16	Storing in (P)SI Module (Accessory) and Database Operations (Feature KB01) 58	22.4	Device Return and Environmentally Compatible Disposal 69
16.1	Storing Measurement Data in the (P)SI Module 58	23	Repair and Replacement Parts Service Calibration Center* and Rental Instrument Service 69
16.2	Database Operations 58		
16.2.1	Storing Test Results to the Test Instrument 58	24	Product Support 70
16.2.2	Uploading Report Templates into Test Instrument, Reading Out From the Test Instrument, Editing at the PC and Re-Saving to the Test Instrument 58		
16.2.3	Reading Out and Saving Test Results / Test Data from the (P)SI Module 58		
17	Recognition of Probe to Protective Conductor (Feature KD01) 58		
18	Storing Test Results and Printing in Report Form 59		
19	Characteristic Values 60		

1 Applications

1.1 Table: Types of DUTs – Tests – Regulations

	Start-up and Modifications	Testing after Repairs		Periodic Testing		Routine Testing			
		DIN VDE 0701-0702:2008	IEC 62353:2007 DIN EN 62353:2008	DIN VDE 0701-0702:2008	IEC 62353:2007 DIN EN 62353:2008	DIN EN 60950/50116	DIN EN 61010	DIN EN 60335/50106	IEC 60601/DIN EN 60601
Devices under test to be tested in accordance with the following regulations	IEC 62353:2007 DIN EN 62353:2008 (VDE 0751-1)								
Laboratory instruments Measuring and control instruments		•		•			•		
Voltage generation devices		•		•					
Electric tools		•		•				•	
Electric heating devices		•		•				•	
Electric motor devices		•		•				•	
Lamps		•		•				•	
Devices for entertainment electronics, information and communications technology		•		•				•	
Cable reel, extension and connection leads		•		•				•	
Data processing and office equipment		•		•		•			
Electrical medical devices, application parts	•		•		•				•



Attention!

The test instrument may not be used for measurements within electrical systems!

Applicable Standards

German National	European	International
DIN EN 61010	EN 61010	IEC 61010
DIN EN 60601	EN 60601	IEC 60601
DIN EN 60335-1	EN 60335-1	IEC 60335-1
DIN EN 60950	EN 60950	IEC 60950
IEC 62353:2007 DIN EN 62353:2008 (VDE 0751-1)	EN 62353	IEC 62353

1.2 Table: Individual Measurements and Regulations

Individual Measurements per Regulation	Test Current [A]	DIN VDE 0701-0702	DIN VDE 0701	DIN VDE 0701	DIN VDE 0701	DIN EN 60950	DIN EN 61010	DIN EN 60335	IEC 62353	IEC 601/EN 60601 2nd	IEC 601/EN 60601 3rd
Protective Conductor Resistance	0.2	•	•	•					•		
	10								•		
	25					•	•	•	•	•	•
Insulation Resistance		•	•		•						
Equivalent Leakage Current		•	•	•	•						
High-Voltage Test						•	•	•		AC	AC
Equivalent (Device) Leakage Current								•	•		
Equivalent Patient Leakage Current									•		
Residual Current		•	•		•				•		
Contact Current		•	•		•	•	•			•	•
Earth Leakage Current										•	•
Patient Leakage Current									•	•	•
Total Patient Leakage Current											•
Patient Auxiliary Current										•	•
Device Leakage Current									•		
Single Fault Conditions	N							•		•	•
	PE						•			•	•
Mains at Application Part										•	•

Key

Standards printed in grey half-tone will be superseded by the new DIN VDE 0701-0702:2008 standard.

- Required test

1.3 Table: Leakage Current Types

DIN VDE 0701-0702	IEC 62353 (VDE 0751-1)	DIN EN 60601-1	The following is measured:
Equivalent Leakage Current			PROBE (connected to protective conductor) to L & N
	Equivalent Device Leakage Current	$I_{\Delta I}$ interrupted from N	PROBE (connected to protective conductor) to L & N
	Equivalent Patient Leakage Current		L & N & PE to Patient Jacks
Contact Current		Contact Current NC	Probe to PE
	Leakage Current from applied part	Patient Leakage Current NC	Patient Jack to PE
		Patient Auxiliary Current NC	Patient Jack to Patient Jack
		Earth Leakage Current NC	Protective Conductor to PE
	Device Leakage Current during Operation, Direct Measurement		Protective Conductor Interrupted, Probe + PAP to PE
Protective Conductor Current with Residual Current Measurement	Device Leakage Current during Operation, with residual Current Measurement		See chapter 11.5

Key

NC = normal condition

PAP = patient application part

PE = Potential earthing \cong , system protective conductor

PC = Protective conductor of the DUT

1.4 List of Possible Options and Standard Types

Features		00	01	02	03	04	05	06	07	08	09	10	11	XX
Mains Connection for Respective Country	B	D	D + service socket	UK ⁴⁾	F/CZE		DK ⁴⁾			China/AUS ⁴⁾	CH		adapter set ^{2) 4)}	
User Interface Language	C	D	UK	F	I	E	CZE	NL						
High Voltage Testing HV-DC	F	without		max. 6.126 kV DC (≧ 4 kV AC)										
AC Test Current 50/60 Hz for Protective Conductor Measurement	G	10 A	25 A											
Test Sequence for IEC 60601	KA	without	with											
Data Memory for up to 125 Tests ⁵⁾	KB	without	with											
Recognition of Probe to Protective Conductor	KD	without	with											
Direct Printing after each Measurement for Automatic Test Sequences ¹⁾ Read-Out via RS232	KE	without	with											

¹⁾ Each measured value is documented in this case, as opposed to the results of a test sequence for which only the poorest value for each given test is displayed. (via the PSI module, the SECUSTORE storage adapter or a PC)

²⁾ Adapter set for international use (comes with Feature B01)

⁴⁾ if adapter (feature B11) is applied: HV-DC max. 1.5 kV DC

⁵⁾ without function test values and without comments on DUT

Designation	Type	Article Number
Test instrument with test current 200 mA DC and 10 A AC Sequences for IEC 61010, IEC 60335, IEC 60950 and IEC 60601, data memory for up to 125 tests	SECULIFE ST	M693A
Same instrument as M693A, however, suited to international use with adapter set for mains connection in the respective user country and English user interface language	SECULIFE ST	M693B

Designation	Type	Article Number
Same instrument as M693A, however, with test current 200 mA DC and 25 A AC, additionally with high-voltage test max. 6.126 kV DC (≧ 4 kV AC)	SECULIFE ST HV	M693C
Same instrument as M693C, however, suited to international use with adapter set (application of adapter: high-voltage test max. 1.5 kV DC) for mains connection in the respective user country and English user interface language	SECULIFE ST HV	M693D

2 Safety Features and Precautions

This instrument fulfills the requirements of the applicable European and national EC guidelines. We confirm this with the CE marking. The relevant declaration of conformity can be obtained from GMC-I Messtechnik GmbH.

The test instrument has been manufactured and tested in accordance with the following safety regulations:

IEC 61010-1 / DIN EN 61010-1 / VDE 0411-1, DIN VDE 0404, DIN VDE 0413 Part 2 and 4 and DIN VDE 0104 (Feature F02 or **SECULIFE ST HV**)

Only when used for its intended purpose, the safety of the user, the test instrument and the device under test (electrical equipment or electrical medical devices) is assured.

Read the operating instructions carefully and completely before placing your test instrument into service, and follow all instructions contained therein. Make sure that the operating instructions are available to all users of the instrument.

Tests may only be performed by a qualified electrician or under the supervision of a qualified electrician. The user must be instructed by a qualified electrician concerning performance and evaluation of the test.



Note

Manufacturers and importers of electrical medical devices must provide documentation for the performance of maintenance by trained personnel.

Observe the following safety precautions:

- The instrument may only be connected to electrical systems with 230 V/240 V which conform to the applicable safety regulations (e.g. IEC 60346, VDE 0100) and are protected with a fuse or circuit breaker with a maximum rating of 16 A.
- Measurements within electrical systems are prohibited.
- Be prepared for the occurrence of unexpected voltages at devices under test (for example, capacitors can be dangerously charged).
- Make certain that the measurement cables are in flawless condition, e.g. no damage to insulation, no interruptions in cables or plugs etc.
- When using a probe with coil cable (SK2W):
Grip the test probe firmly, for example after insertion into a jack socket. Tensioning at the coil cord may otherwise cause the test probe to snap back resulting in possible injury.

- **Measurement of Insulation Resistance and Equivalent Leakage Current**
This test is performed with a maximum voltage of 500 V, with a current limit having been set ($I < 3.5 \text{ mA}$). However, contacting the terminals (3 or 2) causes an electric shock which, in turn, may result in accidents.
- **Leakage Current Measurement**
During leakage current measurement it is imperative to ensure that the device under test is operated at line voltage. Exposed conductive parts may be charged with hazardous contact voltage during the test and may consequently not be touched under any circumstances. (There is a power shutdown as soon as the leakage current is higher than approx. 10 mA).



Attention!

The function test may only be performed after the DUT has successfully passed the safety test!

Switching loads on and off

When switching the DUT on or off under load it is imperative that you adhere to the order indicated below. This helps to prevent excessive wear and tear of the mains relays at the test instrument.

Before the measurement:

- 1) **DUT**: Switch the DUT off at the proprietary switch.
- 2) **SECULIFE ST** or **SECULIFE ST HV**: Apply line voltage to the test socket .
- 3) **DUT**: Switch on the DUT at the proprietary switch.

After the measurement:

- 4) **DUT**: Switch the DUT off at the proprietary switch.
- 5) **SECULIFE ST** or **SECULIFE ST HV**: Disconnect the test socket from the line .

The measuring and test instrument may not be used:

- If it demonstrates visible damage
- With damaged connector cables, measuring cables or patient ports
- If it no longer functions properly
- After extraordinary stresses due to transport

In such cases, the instrument must be removed from operation and secured against unintentional use.

Meanings of Symbols on the Instrument

The symbols on the instrument have the following meanings:



Warning regarding dangerous electrical voltage



Warning concerning a point of danger
(Attention: observe documentation!)



Test socket



Mark of approval from VDE test authority



Indicates EC conformity



This device may not be disposed of with the trash. For further details on the WEEE marking, please refer to our website www.gossenmetrawatt.com and enter search term 'WEEE'.

2.1 Notes Regarding the High-Voltage Test (only Feature F02 or SECULIFE ST HV)

The KS13 cable set, or similar cable sets, may not be used for the high-voltage test. The high-voltage test may only be performed directly via the test socket!



Attention!

Do not hold the device under test in your hand during testing, especially when testing safety class II devices.

Make sure that the device under test does not make contact with any equipment or persons during testing.

Liability Exclusion

In the event of sparkover, PCs operated in proximity to the test instrument may “crash” resulting in data loss. All data and programs should be suitably backed up before high-voltage testing is performed, and computers should be shut down if necessary. A crash may occur even if no RS 232 connection has been established.

The manufacturer of the test instrument assumes no liability for direct or consequential damage to computers, peripherals or data which occurs during high-voltage testing.

The manufacturer assumes no liability for defects at the device under test which result from high-voltage testing. As a rule, defects can only occur at devices under test which are not in compliance with applicable standards, which were previously damaged or which have been improperly repaired, because high-voltage testing is required for type and routine testing by IEC 61010-1/EN 61010-1 / VDE 0411, part 1, as well as EN 60335, EN 60601 and EN 60950.

3 Initial Start-Up

3.1 Connection to the Mains (115 V / 230 V, 50 Hz / 60 Hz)

- ⇨ Connect the mains plug at the test instrument to the mains power outlet. The function selector switch can be set to any position.
- If a mains outlet (earthing contact outlet) is not available, or if only a 3-phase outlet is available, the adapter socket can be used to connect the phase conductor, the neutral conductor and the protective conductor. The adapter socket has three permanently attached cables and is included with the KS13 cable set.



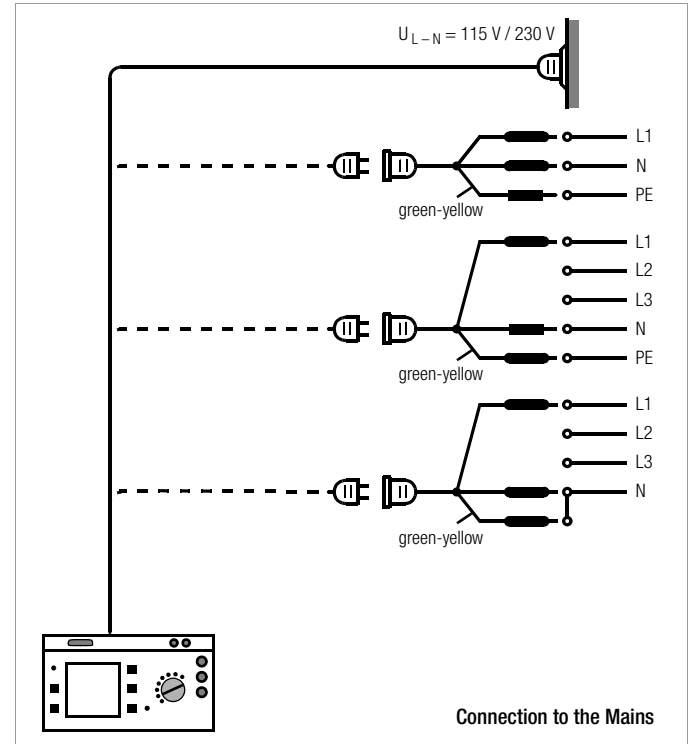

Attention!

If connection is not possible via an earthing contact outlet: Shut down mains power first. Then connect the cables from the coupling socket to the mains using pick-off clips in accordance with the diagram. Disconnection from mains power is only possible with the mains plug.



3.2 Automatic Recognition of Mains Connection Errors

The test instrument automatically recognizes mains connection errors, if the conditions in the following table have been fulfilled. The user is informed of the type of error, and all measuring functions are disabled in the event of danger.

Type of Mains Connection Error	Message	Condition	Measurements
Phase conductor L at protective conductor PE to finger contact (↔ key)	Text appears at LCD	Press  key $U > 100 \text{ V}$	disabled
Protective conductor PE and phase conductor L reversed and/or neutral conductor N interrupted	 lamp lights up	Voltage at PE $> 65 \text{ V}$	impossible (no supply power)
Contact voltage at protective conductor PE to neutral conductor N	Text appears at LCD	$U > 50 \text{ V}$	disabled, although disabling can be deactivated ¹⁾
Mains voltage too low	 lamp lights up	$U_{L-N} < 180 \text{ V}$	possible under certain circumstances

¹⁾ In SETUP – test sequence – IT system



Attention!

If you discover during the protective conductor potential test that **the mains protective conductor is charged with voltage** (in accordance with the two cases mentioned first), **you may no longer perform any measurements with your test instrument**. Voltage is actually present at the exposed earthing contacts of the standard socket (21) as well and may be dangerous to you. Disconnect the test instrument from the mains immediately and see to it that the defect at the mains connection is repaired.



Note

Voltage at the electrical system's protective conductor PE may result in distorted measurement values during testing for the absence of voltage, or during leakage voltage measurements.

4 General Notes

4.1 Online Instructions

Integrated online instructions inform the operator regarding all required connections, necessary work steps, operator errors, measurement results and more in all measuring modes. Information and test results appear at the dot matrix LCD in clear text.

4.1.1 Changing the User Interface Language

If you require a different language for the user interface of the test instrument, you can load it into your test instrument by means of the update and options installation program „SECU-Up“. The program is available for download from our website www.gossenmetrawatt.com (Products > Software > Software for Testers > SECU-Up).

Upon installation on your PC and starting the program, you proceed by selecting the „Update“ menu and choosing a language from the following list:

Deutsch, English, Français, Italiano, ...

Only one language at a time can be installed on the test instrument, the one previously installed is overwritten in the process.



Attention!

During data transmission, the test instrument and PC may not be disconnected from the mains power supply under any circumstances. No other programs under WINDOWS may be activated during the update.

4.1.2 Automatic Safety Class Selection

Depending upon the type of mains plug or the connection configuration for the device under test, the test instrument recognizes the respective safety class and recommends its use for the measurement to be performed.

4.1.3 Manual or Automatic Operating Sequences

Depending upon selections made in the setup menu (selector switch in the Auto position), the next measurement is started automatically after the current measurement has been completed, or can only be started after manual acknowledgement. The integrated online instructions are adequate for most tests and measurements. However, the contents of these operating instructions should nevertheless be read and observed.

4.2 Online Help

Online help can be queried and displayed at the LCD for all measuring and test functions, and for almost all settings. Schematic diagrams which illustrate proper connection of devices under test to the test instrument can be displayed as well.

⇨ Press the following key in order to query online help:



⇨ Press the same key again in order to exit online help.



Note

Online help can be queried during measurement by pressing and holding the help key.

4.3 Adjusting Contrast

Auto



Set the selector switch to Auto.



Select the "Setup" menu, "return" is highlighted.



Activate contrast adjustment.



Press and hold the ENTER key.



Adjust contrast.



Return to the menu.

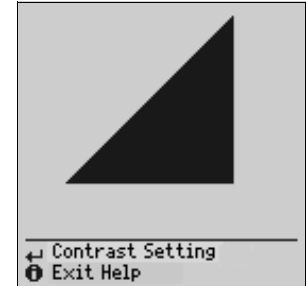

Store the contrast setting to permanent memory with the save function in the setup menu.

4.4 Configuring Device Parameters, Setting Date and Time

Device parameters and functions which are valid for all selector switch positions can be activated or deactivated with the selector switch in the **Setup** position (see chapter 8 on page 18).

4.5 Configuring Measurement and Sequence Parameters

Measurement and sequence parameters, as well as functions, can be activated or deactivated in the **setup** menu (selector switch in the **Auto** position) for the respective test regulation. Refer to chapter 15.3 on page 39 for the significance of the various parameters.

4.6 Setting Limit Values

Upon delivery, the limit values set forth (at the point in time of issue) in applicable national and international standards are stored to the test instrument. Limit values for each of the respective standards can be queried and changed if required with the **setup** menu (selector switch in the **Auto** position), but changes can only be made which result in even stricter testing than is required by the respective standard.

Newly entered limit values become effective immediately. However, these are only stored to memory permanently after activating the **store** function in the **setup** menu.

If the limit values set forth in the standards for certain safety classes need to be restored despite individualized settings, the menu function **all values per standard** in the **limit values** sub-menu must be selected and acknowledged with the  key.

If the limit values set forth in the standards are changed, the instrument's device software can be updated via the RS 232 interface.

4.7 Saving the Settings

All of the settings and changes which have been entered to the **configure**, **limit values** (selector switch in the **Auto** position) and **zero point (temperature measurement)** (selector switch in the **Aux** position) menus, as well as the selected **contrast** setting are retained until the selector switch is turned, or the test instrument is disconnected from mains power. If settings and changes should be retained even after mains power has been interrupted, they must be saved in the **setup** menu for the respective test regulation or selector switch position.

5 Classification of Devices Under Test

5.1 Safety Classes

Devices assigned to all of the following safety classes are equipped with basic insulation, and provide for protection against electrical shock by means of various additional precautions as well.

Safety Class I Devices

Exposed, conductive parts are connected to the protective conductor so that they are not charged with voltage if the basic insulation should fail.

Safety Class II Devices

These devices are equipped with double insulation or reinforced insulation.

Safety Class III Devices and Devices with Internal Power Supply

These devices are powered with Safety Extra Low Voltage (SELV). Beyond this, no voltages are generated which exceed SELV. These devices may not be connected to the mains. They may only be connected to the test instrument at jacks 1 through 3.

Note: The DUT may only be connected to jacks 1 to 3 at the test instrument. It is only possible to perform a visual inspection, a measurement of the insulation resistance or the supply voltage, see parameter “SC III U_V ” on page 39.

Classification Parameter (in the Sequence ... menu)

The test instrument always performs testing in accordance with the strictest limit values of the respectively selected safety class. The test is failed if this limit value is exceeded.

However, higher limit values are allowed for certain devices under test.

If the classification parameter has been activated (= x), the user is asked if higher limit values are allowable for these devices. If the user responds with “Yes”, the DUT is reevaluated and the test may be passed.

Devices with Internal Power Supply

Devices with internal power supply are tested like permanently connected Safety Class II or III devices.

5.2 Application Parts (electrical medical devices)

Type B Application Parts (body)

Devices of this type are suitable for both internal and external patient applications, except for use in direct proximity to the heart.

These devices provide for adequate protection against shock especially as regards:

- Reliable leakage current
- Reliable protective conductor connection if utilized

Devices of the following safety classes are allowable: I, II, III or devices with internal electrical power supply.

Type BF Application Parts (body float)

Same as type B, but with type F insulated application parts.

Type CF Application Parts (cardiac float)

Devices of this type are suitable for use directly at the heart. The application part may not be grounded.

Devices of the following safety classes are allowable: I, II or devices with internal electrical power supply.

6 Abbreviations

AE	Error condition: application part grounded	MSELV	Medical safety extra-low voltage
AP	Apparent power (during function test)	N	Neutral conductor connection of DUT
B, BF, CF	Classifications for application parts	NC	Normal condition
DEFI	Defibrillator	OE	Operational earth
ΔI	Residual current, fault current (during function test)	P	Active power (during function test)
ΔI_{\max}	Maximum residual current (during function test)	PA	Functional earth (equipotential bonding)
RC_{wc}	Residual current worst case	PE	Protective conductor connection of DUT
HE	Error condition: housing grounded	PF	Power factor (during function test)
I_{CLIP}	Current at clip-on meter	R	Resistance
$I-EHC_{SCII}$	Equivalent device leakage current for devices with additional safety class II components	R_{INS} , R-INS	Insulation resistance
$I-EHL_{A1/A2}$	Equivalent device leakage current with note A1/A2 (cross-reference within the standard)	R-INS AP-PE	Insulation resistance: application part to PE
$I-EHL_{FR\pm PE}$	Equivalent device leakage current for portable x-ray devices +PE: with additional protective conductor -PE: without additional protective conductor	R-INS _{INT. KARD.}	Insulation resistance: intercardiac (application in proximity to the heart)
I_{EL} , I-EL	Equivalent leakage current	R-INS NL-PE	Insulation resistance: neutral/phase conductor to PE
I_{EDL} , I-EDL	Equivalent device leakage current (current at protective conductor)	R_{PE} , R-PE	Protective conductor resistance
I_{EPL} , I-EPL	Equivalent patient leakage current	R-PE±mains	Protective conductor resistance limit value for +mains: device under test with mains cable -mains: device under test without mains cable (protective conductor resistance limit value for mains cable only = 0.1 Ω)
I_L , I_{HL} , I-HL	Leakage current (differential, probe or contact current)	SELV	Safety extra-low voltage
$I_{L(max)}$ (I_a)	(Maximum) load current (during function test)	SFC	Single-fault condition
I_{LC}	Device leakage current	t	On-time (during function test)
I_{PA}	Patient auxiliary current	T, Temp	Temperature
I_{PE}	Earth leakage current (current at protective conductor)	$U_{AC/DC}$	AC/DC voltage
I_{PL}	Patient leakage current	U_{REF}	Reference voltage: voltage to which leakage current is related (as a rule nominal line voltage)
I_{PMAP}	Mains to application part (patient leakage current measurement)	U_{HV} , U-HV	High-voltage
I_{RC} , (I_{Re})	Residual current (current at protective conductor during automatic test sequence)	U_{INS} , U-INS	Test voltage for insulation measurement
I_C , I_{HL} , I-HL	Contact current (housing leakage current)	U_{LN} , U-LN	Line voltage
IT-system	The IT system makes no direct contact between active conductors and grounded parts: bodies within the electrical system are grounded.	U_{MEAS}	Voltage at which testing was executed. Displayed for all leakage current measurements.
L	Phase conductor connection of DUT	U_{Probe}	Probe voltage
MedGV	German medical device ordinance	W	Electrical energy (during function test)
MLV	manufacturer's limit value	ZVEH	General Association of German Electricians
MPG	German medical product law		

7 Connecting the Device Under Test

- ⇨ Connect the DUT in accordance with the schematic diagrams included in the online help function.

Connection of the DUT to the test instrument depends upon:

- **The type of device under test:**
electrical equipment or not, with or without application parts
 - **The type of connector included with the DUT:**
 - With plug (“to test socket” parameter), applies to EL1 adapter as well
 - Without plug, single or multi-phase connection (“to jacks” parameter)
 - No connection to tester (“permanent connection” parameter), see also chapter 3.1
- Whether or not an adapter is used:**
- Adapter to socket (customer specific adapter)
 - AT3-II S to socket, adapter for devices which are equipped with 5-pole, 16 A CEE plugs
 - AT3-III E to socket, adapter for devices which are equipped with 5-pole, 32 A CEE plugs, see AT3-III operating instructions for test sequence.
- The DUT’s safety class (I, II or III)



Note

The DUT must be switched on for all tests. Switches, relays, temperature regulators etc. must all be taken into consideration.

The test instrument automatically recognizes whether or not the DUT is connected to jacks 1 through 3. The instrument also recognizes whether or not the DUT has been connected to the test socket. As a default setting, the program sequence assumes that the plug from the DUT has been connected to the test socket.



Note

Safety Class II Devices with Safety Class I Mains Plugs

If the device under test is equipped with a safety class I plug although it complies with safety class II, safety class I is recognized by the test instrument. If this is the case, switch from safety class I to safety class II in the initial menu.

If the test instrument is unable to automatically recognize how the DUT has been connected, the recommended connection setup should be double checked and determined manually if necessary.

- ⇨ Position the cursor at the third line in the start menu for the test sequence.
- ⇨ A selection of possible connection setups can be displayed by activating the key.
- ⇨ Select the desired connection setup with the cursor and acknowledge with the key.

For omitting the protective conductor test in the case of fully insulated devices see page 65.

Protective Conductor and Insulation Resistance Measurements for Permanently Installed Devices Under Test



Attention!

Deactivate the electrical system which supplies power to the device under test before connecting the test instrument!

- ⇨ Remove the mains fuses from the device under test and disconnect the neutral conductor N inside the device under test.

Measuring Contact Current (absence of voltage)

Make sure that the contacted parts are not grounded.

High-Voltage Test (Feature F02 or SECULIFE ST HV)



Attention!

The KS13 cable set, or similar cable sets, may not be used for the high-voltage test. The high-voltage test may only be performed directly via the test socket!

- ⇨ Connect the device under test to the test socket.
- ⇨ Safety class II only: Connect the probe to jacks 4 and 5.



Attention!

Make sure that the application parts are not connected during the high-voltage test!

8 Configuring Device Parameters

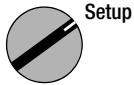

General device parameters can be configured and

saved with the selector switch in the **Setup** position.



Select a menu and acknowledge.



Select parameter and acknowledge, change setting and acknowledge.

Limit values ...

Settings x / –
Illumination

= function activated / deactivated
Background illumination for the LCD. One of three different conditions can be selected with the up and down scroll keys: x: continuously on, –: off numbers 1 through 9: duration in minutes after which illumination is automatically deactivated.

Test time
Reference voltage:

Duration of a single test (0 ... 255 s)
Voltage to which leakage current makes reference (as a rule nominal line voltage)

Earth fault:

During the short-circuit test, testing is also performed to determine whether or not a connection exists between L/N and PE (short-circuit to exposed conductive part). We assume that a short-circuit to an exposed conductive part exists in the event of leakage current greater than 15 mA from L/N to PE. This value should be increased for some DUTs (in particular high-current consumers), because greater leakage currents are present.

Mains wait

Line voltage is first applied to the test socket. However, testing does not begin until after the duration selected in seconds under "Mains pause" has elapsed.

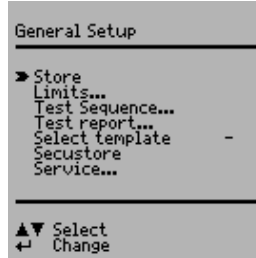

Automode

x: for fully automatic test sequences the messages are mainly suppressed

Test Sequence ...

Settings x / –
Single-fault

= function activated / deactivated
If the single-fault condition has been activated, the test is interrupted as a failure as soon as an error occurs.

Auto Class PSI

Test results (passed or failed) for the various selector switch positions are automatically assigned to the 8 statistics channels.

inc. Service Error

Measurement results are compensated by taking service error into consideration (measuring error).
Testing in IT systems can be performed by suppressing tests for U_{PE-N} . The U_{PE-N} test determines whether or not voltage is present at PE. (Leakage current measurement results may otherwise be distorted.)

IT Network

Acst Sig, Seq

Acoustic signal is generated for: Incorrect connection of the DUT, error in the electrical supply system, next test step.

Acst Sig, Meas

Acoustic signal is generated for: Measured value fluctuations, test current polarity reversal

Auto meas. point

Prerequisite: Feature KD01. An acoustic signal indicates whether or not the probe is connected to the protective conductor. The test sequence is run automatically. Rapid signal frequency: probe connected to PE; slow signal frequency: next measuring point

Direct Print-Out

Prerequisite: Feature KE01, see chapter 18 on page 59.

Reports ...

Reports which have been saved to memory can be selected from a list with an ID number and displayed (see chapter 18 on page 59).

Select template

a report template can be selected for print-out from of 5 different templates.

SECUSTORE

Optimize data transfer for the SECUSTORE adapter connection (in this configuration, no data can be saved to the (P)SI module). Neither is a test report signalled to the RS232 interface.

Service ...

– Time and date settings (if a (P)SI module is used, the same time and date must also be entered to the (P)SI menu)
– Service functions (password required)

9 Measuring Protective Conductor Resistance

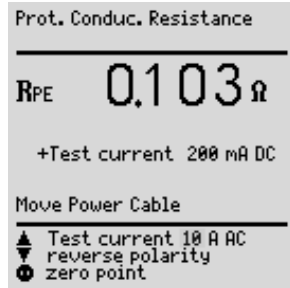
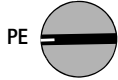

Definition

Protective conductor resistance is the sum of the following resistances:

- Connector cable or device connector cable resistance
- Contact resistance at plug and terminal connections
- Extension cable resistance if utilized

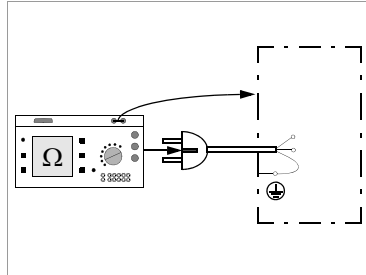

Resistance is measured:

- Between each *conductive part of the housing* and the earthing contacts at the mains and the device plug (if a removable mains connector cable is used), or the protective conductor terminal for permanently installed devices.
- as 4-pole measurement
- Between the earthing contacts at the mains plug and the earthing contacts at the device plug for *device connector cables*
- Between the earthing contacts at the mains plug and the earthing contacts at the coupling socket for *extension cables*

Connecting Safety Class I Devices to the Test Socket

When the DUT is connected, resistance is measured between the protective conductor terminal at the test socket or at the PE jack and the probe connection at the DUT (contact with conductive parts of the housing).

- ➔ In order to measure protective conductor resistance, contact a conductive part of the housing with the probe, which is connected to the protective conductor.

During measurement, the **connector cable** must only be moved in as far as it is accessible during repair, modification or testing.

If a change in resistance occurs during the manual test step of the continuity test, it must be assumed that the protective conductor is damaged, or that one of the connector contacts is no longer in flawless condition.

Testing Extension Cables

See test sequence in chapter 15.7 on page 46.



Note

“Connection of the DUT: SC I/II” is not displayed when the test is performed individually, but rather only during the automatic test sequence.



Selecting Test Current and Polarity

Test current amperage (200 mA DC or 10 A AC (Feature G00 or SECULIFE ST) or 200 mA DC, 25 A AC (Feature G01 or SECULIFE ST hv)) as well as **polarity** can both be changed by pressing the or the key.

Testing with 10 A Test Current (Feature G00 or SECULIFE ST) or 25 A (Feature G01 or SECULIFE ST hv)

The test has a **maximum duration** of 30 s (fixed value) if 10 A or 25 A test current is used. After this time period has elapsed, the last measured value is frozen and “data hold, measurement stopped” appears at the display. If the test instrument becomes excessively warm, testing cannot be repeated until after a waiting period of 1 minute. When testing with 10 A or 25 A, the last measurement can be repeated if the test results in failure.

Combined Testing – Differential Protective Conductor Resistance

Zero balancing is also possible for protective conductor measurement. With zero balancing, all subsequent measurements are adjusted with an offset such that 0Ω is displayed for a selected reference point which is connected to the protective conductor. When test points are contacted with the probe which are electrically connected to this reference point, differential resistance ΔR_{PE} between the reference point and the contacted test point is displayed. The mains release key  must be activated during measurement in order to perform zero balancing. Press key  „Store value“ in order to save the reference and/or correction value. The message „Zero point corrected“ concerning the reference value is displayed during all future measurements.

Attention: It is absolutely essential to delete the reference value after the reference value has been stored and the test has been performed as it is taken into account in all future tests. To delete the value, the procedure is the same as for storage, press key  „Delete value“.

9.1 Maximum Allowable Limit Values for Protective Conductor Resistance for Connector Cables with a Length of up to 5 m

Test Standard	Test Current	Open-Circuit Voltage	R_{PE} Housing – Device Plug	R_{PE} Housing – Mains Plug	
VDE 0701-0702:2008	> 200 mA	$4 V < U_L < 24 V$		0.3Ω ¹⁾	
IEC 62353 (VDE 0751-1)				+ 0.1Ω ²⁾	
EN 61010	10 A / 25 A ³⁾		0.2Ω	0.3Ω	
EN 60335	to test socket only		0.1Ω	0.2Ω	0.2Ω ²⁾
EN 60950					
EN 60601					

¹⁾ This value may not exceed 1Ω for permanently connected data processing systems (DIN VDE 0701-702, DIN VDE 0701, part 240).

²⁾ Permanently connected cable

³⁾ Feature G00 = 10 A (SECULIFE ST) / G01 = 25 A (SECULIFE ST HV)

10 Insulation Measurement

Iso / HV

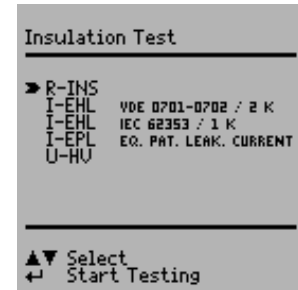

10.1 Insulation Resistance R_{INS}

Definition

Safety Class I

Insulation resistance is measured between short-circuited mains terminals and the protective conductor.

Safety Classes II and III

Insulation resistance is measured between short-circuited mains terminals and external conductive parts which can be contacted with the probe.

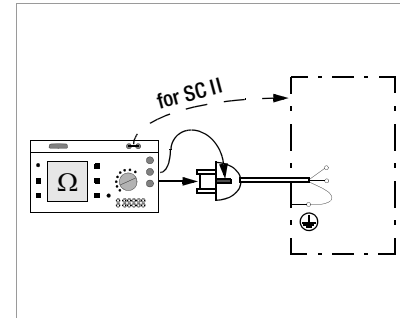

Exception for Permanently Installed Safety Class I Devices



Attention!

Deactivate the electrical system which supplies power to the device under test before connecting the test instrument!

- ⇨ Remove the mains fuses from the device under test and disconnect the neutral conductor N inside the device under test.
- ⇨ Connect the probe to phase conductor L at the device under test in order to measure insulation resistance.

Sequence



Attention!

Measurement of Insulation Resistance (equivalent leakage current)
This test is performed with a maximum voltage of 500 V, with a current limit having been set ($I < 3.5 \text{ mA}$). However, contacting the terminals (3 or 2) causes an electric shock which, in turn, may result in accidents.



Note

All switches at the device under test must be set to the ON position during measurement of insulation resistance. This also applies to temperature controlled switches and temperature regulators.
Measurement must be performed in all program stages for devices equipped with program controllers.

R-INS



Start measurement.

Nominal voltage is 500 V DC in this case.

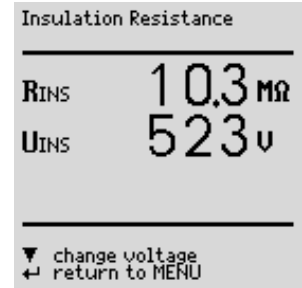

Nominal voltage can be adjusted within a range of 50 V to 550 V DC.



Note

When insulation is first started from the menu, nominal voltage is always set to 500 V. Open-circuit voltage is always greater than nominal voltage.

Minimum Allowable Limit Values for Insulation Resistance

Test Standard	Test Voltage	R _{INS}			
		SC I	SC II	SC III	Heat
VDE 0701-0702:2008	500 V	1 MΩ	2 MΩ	0,25 MΩ	0,3 MΩ *
IEC 62353 (VDE 0751-1)		2 MΩ	7 MΩ		
					
		70 MΩ	70 MΩ		

* for Safety Class I devices with activated heating elements

Notes

All exposed, conductive parts of safety class II and III devices, as well as of battery-powered devices must be scanned with the probe and insulation resistance and/or leakage current must be measured.

Batteries must be disconnected from their terminals during testing of battery powered devices.

10.2 Equivalent Leakage Current

General

The equivalent leakage current measurement is a method for measuring protective conductor current (DIN VDE 0701-0702) and/or device leakage current (IEC 62353 (VDE 0751)).

A high-impedance power supply is connected between the short-circuited mains terminals and all exposed metal parts of the housing (which are connected to one another).

Measurement of Equivalent Leakage Current I_{EL} per DIN VDE 0701-0702

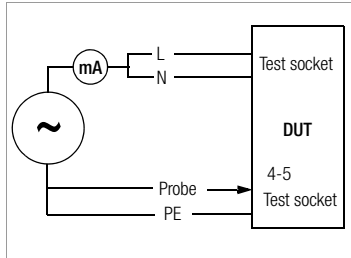

Measurement of Equivalent Device Leakage Current I_{EDL} (per IEC 62353 (VDE 0751-1))

The patient ports are linked with each other and are connected to the same point on the housing.

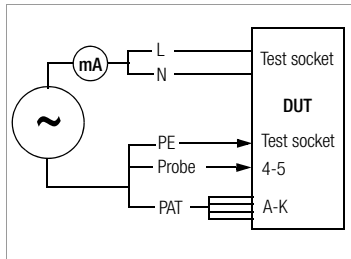

Equivalent Patient Leakage Current I_{EPL} (IEC 62353 (VDE 0751-1))

Test Setup

A high-impedance power supply is connected between each patient port and all exposed metal parts of the housing (which are connected to one another). The mains terminals are short-circuited, and connected to the same point on the housing.

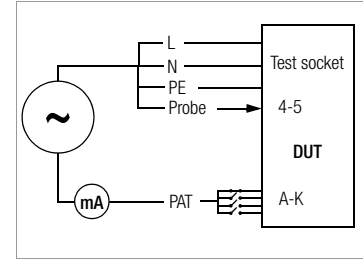

Measurement

The current which flows over the insulation at the device under test is measured separately for each application part.

Measurement is always performed with an AC power supply with current limiting. Varying line voltages are taken into account.

Maximum Allowable Limit Values for Equivalent Leakage Current in mA

Test Standard	I_{EL}	I_{EDL}	I_{EPL}		
VDE 0701-0702:2008	SC I: 3.5 1 mA/kW ¹⁾ SC II: 0.5				
		SC II	0.2	Type BF	5 ²⁾
IEC 62353 (VDE 0751-1)		SC I (parts within or connected to PE)	1	Type CF	0.05 ²⁾
		Permanently connected devices with PE	10		
		Portable x-ray devices with additional PE	5		
		Portable x-ray devices without additional PE	2		
		Devices with mineral insulation	5		

I_{EL} Equivalent leakage current

I_{EDL} Equivalent device leakage current

I_{EPL} Equivalent patient leakage current

PE Protective conductor

¹⁾ for devices with heating power of ≥ 3.5 kW

²⁾ with and without line voltage applied to the application part

Connection

Refer to the schematic diagrams included with the online help for connection instructions.

Connection Exception for Permanently Installed Safety Class I Devices

Current is measured between the probe, with which the L and N conductors must be contacted, and the protective conductor terminal PE at the device under test for permanently installed safety class I devices under test.



Attention!

Disconnect mains power before connecting the test instrument!

- ⇔ Remove the mains fuses from the device under test and disconnect the neutral conductor N inside the device under test.
- ⇔ Connect the probe to phase conductor L and neutral conductor N at the device under test in order to measure equivalent leakage current.

Sequence

Current is displayed during this type of equivalent leakage current measurement which would flow during leakage current measurement conducted in accordance with device regulations with nominal voltage. Leakage current measurement in accordance with the respective device regulations is usually not possible, because the device would have to be set up in an electrically isolated fashion, or connected to an earth isolated power supply to this end.

For the evaluation of measured values during equivalent leakage current measurement please refer to chapter 21.2.

Equivalent Leakage Current I_{EL} DIN VDE 0701-0702 / 2 K



Select the **I-EL** measurement and start.

Equivalent leakage current is measured between short-circuited N and L, and the **protective conductor PE**.

Measuring circuit resistance is equal to 2 k Ω for VDE 0701-0702 for the simulation of the mean body resistance of a human being.

Equivalent Device Leakage Current I_{EDL} for IEC 62353 (VDE 0751-1) / 1 K



Select the **I-EDL** measurement and start

Equivalent device leakage current is measured between short-circuited N and L, and the **probe**.

Measuring circuit resistance is equal to 1 k Ω for IEC 62353/VDE 0751 for the simulation of mean patient resistance.

Equivalent Patient Leakage Current I_{EPL} (IEC 62353 (VDE 0751-1))



Select the **I-EPL** measurement and start

Equivalent patient leakage current is measured between short-circuited N and L and the respective application part. Jacks A through K (application parts) are connected separately for each application part.

Groups of cables or sensors can be assigned to application parts in the test sequence start menu in accordance with IEC 62353 (VDE 0751-1) or EN 60601.

10.3 High-Voltage Test (Feature F02 or SECULIFE ST hv)

Only safety class I and II devices can be tested, which can be connected to the test socket.

The high-voltage test is performed with direct voltage. In order to comply with requirements for alternating voltage, testing is performed with 1.5-fold direct voltage. This multiplier is applied automatically during testing. A selected nominal voltage of 3.5 kV thus results in a DC output voltage of 5.25 kV.

Output voltage is measured for the entire duration of the test, and its minimum value is determined. The minimum voltage value is indicated as the test result. If this value is less than the pre-selected test voltage, the test is failed.

The conversion factor must be taken into consideration for testing and calibration of the **SECULIFE ST hv**.

The device is designed such that special measures in accordance with DIN VDE 0104 (high-voltage test) need not be observed.

This is accomplished by means of the following characteristics:

1. Continuous short-circuit current is less than 3 mA (DC).
2. Discharge energy (at 5.25 kV) is less than 350 mJ.

In order to comply with high-voltage test regulations despite the minimal continuous short-circuit current, the charging capacitors are connected to the test socket (L, N) with relatively low-value protective resistors. This results in a peak short-circuit current value of approximately 5 A (at 5 kV), which causes plainly audible and visible sparking.

Connection

High-voltage testing can only be performed via the test socket. The protective conductor at the socket is grounded during the high-voltage test.

Safety class I:

The test is conducted between the short-circuited mains poles L-N and the protective conductor PE of the test socket.

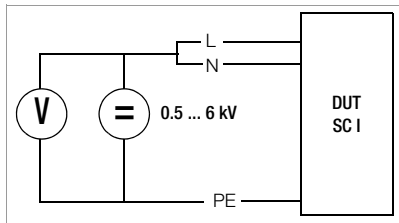

If safety class II is recognized, the test is conducted between the short-circuited conductors L-N of the test socket and the probe (connection 4-5).

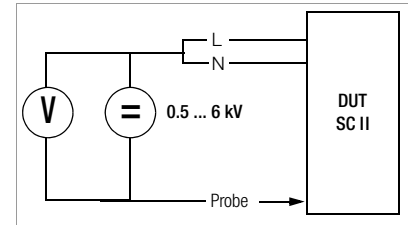

Caution: High-Voltage!

Touch **neither** the test socket **nor** the device under test during voltage testing!

A **high-voltage** of up to **5.5 kV** is present at the test socket output! A current may flow over your body, and although it does not reach life endangering levels, the resulting shock is plainly discernible.

Previous testing of the protective conductor is absolutely essential for safety class I devices because if the protective conductor is interrupted, the high-voltage test does not charge all dielectric material and the scope of testing is thus insufficient.

Connection

- ⇨ Insert the mains plug from the device under test into the test socket.
- ⇨ Safety class II: Connect the probe to jacks 4 and 5.



Attention!

Make sure that the application parts (18) are not connected during high-voltage testing!

Individual Test

- ⇨ Set the rotary selector switch to the Iso/HV position.
- ⇨ Select the **U-HV** menu with the key and acknowledge with the key.
- ⇨ If the device under test has not yet been switched on, a message to this effect appears at the display. Nominal voltage is then selected.

- ⇨ Select the desired nominal voltage from the display with the Δ ∇ key. The instrument multiplies this nominal voltage by a factor of 1.5, which represents the actual test voltage (see chapter 10.3).

Note: For SC I, the test voltage can be set to maximum 1.5 kV.

- ⇨ Test voltage is applied to the test socket, and in turn the device under test, for as long as the \square key is held depressed. Activation of high-voltage is indicated with an acoustic signal.

Currently measured minimum output voltage $U_{HV AC}$ (measured value divided by 1.5), test voltage U_{DC} , and remaining test time are displayed.

- ⇨ Safety class II: Contact all exposed, conductive parts, simultaneously if possible, in order to avoid unnecessarily long test durations or repeats. Avoid contacting individual parts sequentially.
- ⇨ After the key is released, the equivalent AC voltage is displayed which occurred during testing. This voltage is indicated as the test result. If this value is less than the pre-selected nominal voltage, the test is failed.
- ⇨ If you want to repeat the test, press the Δ key. The test sequence is started over again with selection of nominal voltage.



Attention!

If sparkover should occur, the test is immediately interrupted and the voltage measured at the moment sparkover occurred is display as $U_{HV AC}$.

If the device is disconnected from the test socket during testing, even though this is prohibited, the test is immediately interrupted. The following message is displayed: "Caution, device under test is still charged!"

High voltage test	
To Socket	
$U_{HV DC}$	1.56 kV
appropriate AC Voltage	
$U_{HV AC}$	1.03 kV
Test time:	056s

Testing as Part of a Test Sequence

- ⇨ Select the high-voltage menu under the setup function for the respective test regulation in order to set parameters for the high-voltage test.
- ⇨ Enter the desired AC nominal voltages for safety classes I and II. The instrument multiplies the respective AC nominal voltage by a factor of 1.5, which represents the actual DC test voltage (see chapter 10.3). Test voltage is determined based upon the selected, or the automatically recognized safety class.
- ⇨ Save the setup values to memory.
- ⇨ Start the high-voltage test by pressing the \square key, if "manual sequence" has been selected in the setup menu.
- ⇨ Safety class II only: Contact the device under test with the probe.

Activation of high-voltage is indicated with an acoustic signal.

The selected nominal voltage of 3.5 kV results in a DC output voltage of maximum 5.25 kV.

The high-voltage test is ended automatically after the test duration has elapsed.

$U_{HV DC}$: Equivalent test voltage in DC

$U_{HV AC}$: Measured DC value divided by 1.5

If the value $U_{HV AC}$ is less than pre-selected nominal voltage U_{AC} , the test is failed.

High voltage test	
To Socket	
$U_{HV DC}$	1.56 kV
appropriate AC Voltage	
$U_{HV AC}$	1.03 kV
Test time:	056s



Note

In the event of sparkover, the voltage measured at the moment sparkover occurred is displayed in the test results as minimum value $U_{HV AC}$, along with the reason the test was failed.

11 Leakage Current Measurement

I leakage



Select the I_{xx} measurement and start.

Each time line voltage is applied to the test socket, L and N are reversed, if this function has been selected in the leakage current menu (see chapter 11 on page 26).

Attention:

Leakage Current Measurement

During leakage current measurement it is imperative to ensure that the device under test is operated at line voltage. Exposed conductive parts may be charged with hazardous contact voltage during the test and may consequently not be touched under any circumstances. (There is a power shutdown as soon as the leakage current is higher than approx. 10 mA).

Frequency response is taken into consideration in accordance with the diagram to the right when leakage current is measured.

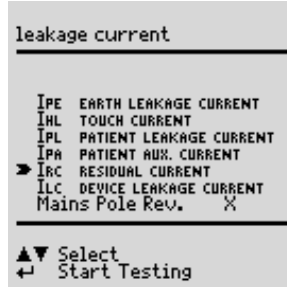
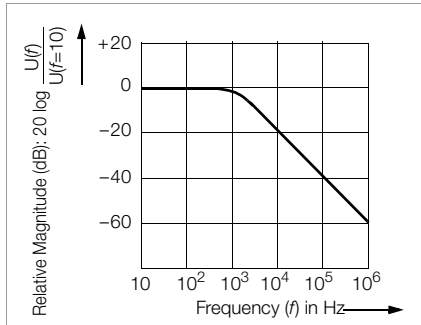

11.1 Earth Leakage Current I_{PE} (Feature KA01)

Current which flows from the power pack over the insulation to the protective conductor, and thus to earth.



Attention!

The protective conductor is disabled during this measurement.

11.2 Contact Current

Current which flows from housing parts which are not connected to the protective conductor via an external conductive connection to earth or another part of the housing. Flow of current via the protective conductor is excluded in this case.

The AC component is measured. The DC component can also be measured if individual measurement is performed (instead of a test sequence).

EN 60601/VDE 0751: The following sequence is programmed for measuring and documenting several exposed conductive parts:

If the acoustic signal chain changes from long to short intervals, it means that measurement is completed and the next measuring point can be selected and scanned (key).

If each measured value is to be recorded (printed), it can be done by pressing the key after each measurement (on condition that „Direct print-out“ is activated, see chapter 18).

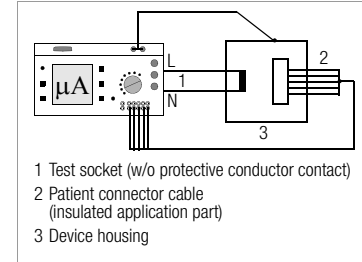

11.3 Patient Leakage Current I_{PL}

Current which flows from an application part via the patient to earth. This current may be caused by an unintentional interference voltage at the patient, and may flow via the patient and an insulated, floating type F application part to earth. Useful patient current is excluded in both cases.

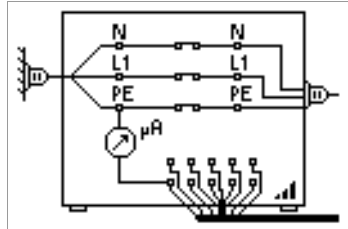

AC and DC components are measured.



Note

Patient leakage current must also be measured if application parts are available.
The displayed test voltage must be documented.

11.4 Patient Auxiliary Current I_{PA} (Feature KA01)

Current which flows within the patient between the electrodes of the application part. Use for intended purpose is assumed. Furthermore, the current should not cause any physiological effects. For example, this is the case for input current from amplifiers, or current used for impedance plethysmography.

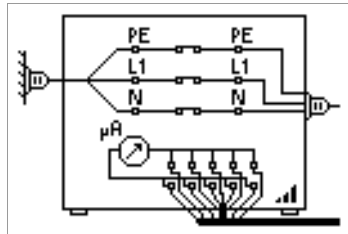

AC and DC components are measured.

11.5 Residual Current I_{RC}

Sum of instantaneous current values which flow via the L and N conductors at the device mains connection (also known as differential current). Residual current is practically identical to fault current in the event of an error. Fault current: Current which is caused by an insulation defect, and which flows via the defective point.

11.6 Device Leakage Current I_{LC} per IEC 62353 (VDE 0751-1)

Device leakage current is the sum of all leakage currents from the housing, all accessible conductive parts and all application parts to PE. Measurement must be performed for both mains polarities and the largest value is documented.

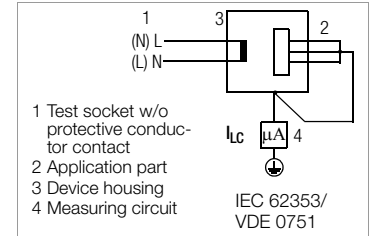

Note

The highest device leakage current value and line voltage must be documented.



Attention!

The protective conductor is interrupted during this measurement.

This page has been deliberately left blank.

12 Multimeter Functions

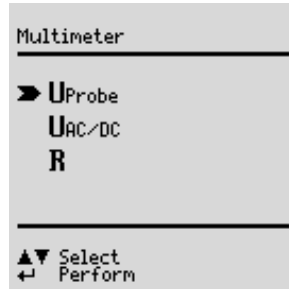
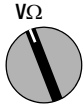

12.1 Probe Voltage U_{probe} – Max. 300 V

Voltage is measured between the mains PE terminal at the test instrument and the probe. In this case the probe can also be used as a phase finder. For IEC 61010: A selection can be made with the **up** scroll key as to whether testing will be conducted under normal conditions, or with interrupted protective conductor.

For conducting the measurement the DUT must be put into service via key  (14).



Start the U_{probe} measurement.

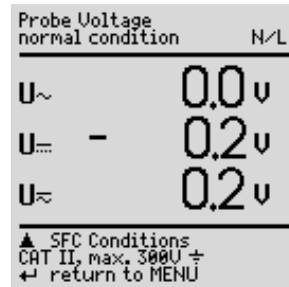

12.2 Alternating / Direct Voltage $U_{\text{AC/DC}}$ – Max. 253 V

Direct, alternating and pulsating voltages of up to 253 V can be measured between the 2 and 3 connector jacks.

Furthermore, it is possible to switch between minimum, maximum and momentary measured value via key . This is particularly useful in combination with the **SECULOAD** test adapter for welding equipment (article number Z745V).

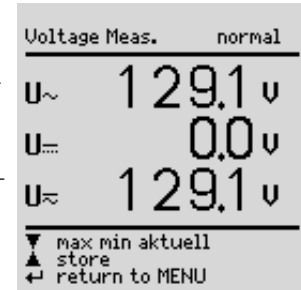

Attention!

Two procedures are to be distinguished as from firmware version 7.24:

Procedure 1. DUT not connected to test socket (permanent connection)

- ⇨ Select switch position $V\Omega$ and then measurement $U_{\text{AC/DC}}$.
- ⇨ Connect the measurement cables to jacks 2 and 3.
- ⇨ Scan the measuring point with the test probes.
- ⇨ Read the measured values.
- ⇨ Remove the test probes from the measuring point and pull off the measurement cables from jacks 2 and 3.
- ⇨ Return to the Multimeter menu with ENTER.

Procedure 2. DUT on test socket *(new! as from firmware version 7.24)*

It is imperative that you observe the specified sequence of test steps:

No device or component may initially be connected to jacks 1 through 3! (Jacks 2 and 3 are short-circuited during all measurements at the test socket; Exception: as soon as the express command to connect the measurement cable appears in the display, short-circuit is cancelled, see below)

- ⇨ Remove all cables that may be plugged into jacks 1 through 3.
- ⇨ Connect the DUT to the test socket.
- ⇨ Select switch position $V\Omega$ and then measurement $U_{AC/DC}$.
- ⇨ Switch the DUT on (a short-circuit test is conducted).
- ⇨ Put the DUT into service by switching line voltage to the test socket with key (14).
- ⇨ **Please do not fail to observe the following:**
Do not connect the measurement cables until the following command appears in the display:
„Connect the measurement cable to jacks 2 and 3 for voltage measurement“.
- ⇨ Scan the measuring point with the test probes.
- ⇨ Read the measured values.
- ⇨ Remove the test probes from the measuring point and pull off the measurement cables from jacks 2 and 3.
- ⇨ Return to the Multimeter menu with ENTER.

Measurement of Safety Extra Low Voltage (see Procedure No. 2, see above)

Line voltage can be switched to the DUT via the test socket with key , e.g. in order to measure **protective extra low voltage** at the DUT output.



Attention!

The voltage measured at the DUT output must be a protective extra low voltage electrically isolated from the mains, otherwise an overcurrent protection device in the building installation may trip.

12.3 Resistance R

Resistance of up to 150 k Ω can be measured between the 1 and 2 connector jacks.



Select the **R** measurement and start.

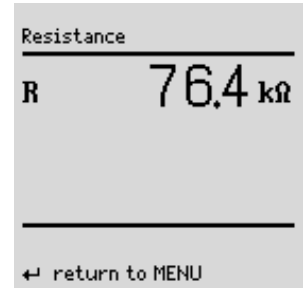

13 Measurements with Accessories

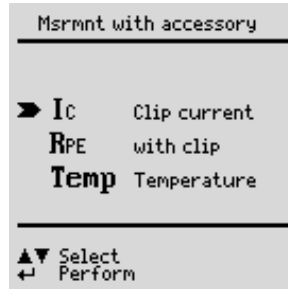

Start the I_{CLIP} measurement.



Select measuring range.

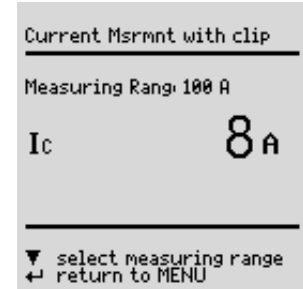

13.1 Alternating Current I_{CLIP} with Clip-On Converter

Connection

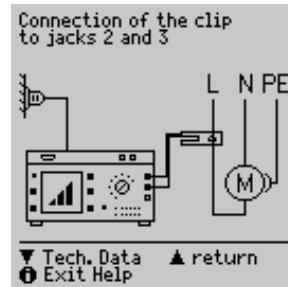

Alternating current can be measured in two measuring ranges (1 mA ... 10 A ~, 1 A ... 100 A~) with a clip-on current-voltage converter connected to the 2 and 3 jacks (e.g. the WZ12C).

13.2 Protective Conductor Resistance R_{PE} via Clip-On Meter

Connection

Protective conductor resistance can be determined with the WZ12C clip-on current transformer.

25 A AC test current (Feature G01 or **SECULIFE ST HV** only):
Use the Z864A shunt in addition to measuring range matching.

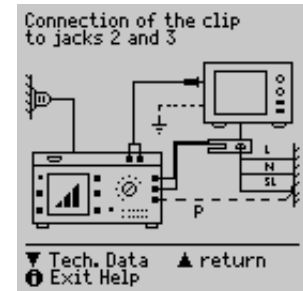

P: potential lead for 4-wire measurement

The potential lead must be connected to the outgoing protective conductor at the distributor.

Cable resistance is measured from the device under test to the test instrument without potential lead P. This value may deviate significantly from actual protective conductor resistance, because the lead is measured along with the test instrument installation. Resistance from the probe terminal to contact P at the protective conductor is measured with the potential lead.



Select R_{PE} measurement and start.

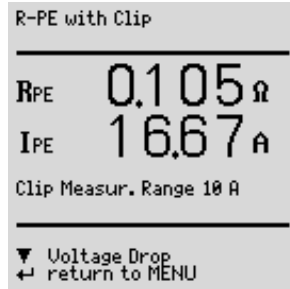

Select the **Temp** measurement and start. Select Pt100 or Pt1000 by means of “select measuring range” with the ∇ key. The temperature unit of measure can be selected in the “TEMPERATURE” Δ setup menu. Selection can be made amongst °C (Celsius), °F (Fahrenheit) or Kelvin. Zero balancing is also accessible via the “TEMPERATURE” setup menu.

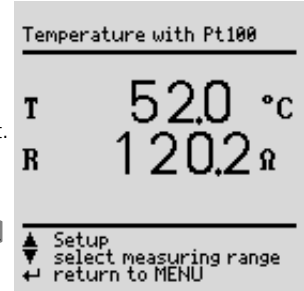

13.3 Temperature T with Pt100/1000 Sensor Connection

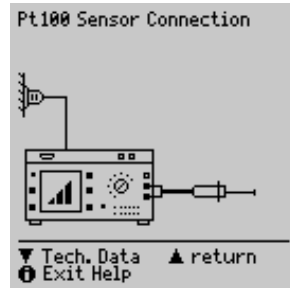

Temperature can be measured within a range of -200 °C to $+850\text{ °C}$ with a Pt100 or Pt1000 sensor (default setting) connected to the PE (1) and N (2) jacks.

Zero Balancing

Sensor cable resistance can be compensated for with this function:

- ⇨ Short circuit the ends of the sensor leads and determine resistance as shown below.

Zero Balancing



The determined value can be stored directly (Δ key), or changed first. The data entry menu is opened with the ∇ key.

- ⇨ Change the measured value manually with the help of the Δ and ∇ keys.
- ⇨ Press the \square key in order to acknowledge the selected value, and to display other menu functions at the bottom of the window.

Save the selected value by activating the “store value” key Δ before exiting the balancing function with the \square key.

The “delete value” command can only be accessed via the “change value” menu. The “no zero balancing” setting is saved at the same time by activating the ∇ key.



14 Function Test



Function Test

The device under test can be subjected to a function test with line voltage via the integrated test socket.

In addition to testing with the selector switch in the function test position, a function test can also be performed immediately after safety testing has been passed in accordance with the selected standard (not possible for safety class III devices).



Attention!

The function test may only be performed after the DUT has successfully passed the safety test.



Note

Each time line voltage is applied to the test socket, phase conductor L and neutral conductor N are reversed, assuming that “polarity reversal = X” is selected in the **I leakage** switch setting.



Note

The function test is only possible if the device under test has been connected to the test socket (21).

Measurements

The function test includes the following measurements:

- Voltage U_{LN} between the L and N conductors
- Residual current ΔI (corresponds to fault current between L and N)
- Load current I_a
- Active power P
- Apparent power AP (calculated)
- Power factor PF ($\cos \varphi$ calculated, display $> 10 W$)
- Electrical energy W
- On-time t for U_{LN} at socket (21)

The following values are also displayed in all test sequences in switch position AUTO after the function test has been completed:

- Maximum residual current ΔI_{max}
- Maximum load current I_{Lmax}
- Maximum active power P_{max}

Power factor is calculated from active power and apparent power.

Power factor corresponds to $\cos \varphi$ for sinusoidal quantities (line voltage and load current).



Attention! Starting the Function Test

For reasons of safety, the device under test must be switched off before the function test is started. This precaution prevents inadvertent start-up of a device under test which may represent a hazard during operation, e.g. a circular saw or a disc grinder.

Ending the Function Test

After completion of the function test, devices under test must be turned off with their own switch – especially devices with relatively high inductivity.

Short-Circuit Test

- 1 Test for shorts between N and L.
- 2 Test to determine whether or not the N or L conductors are short-circuited to the protective conductor.

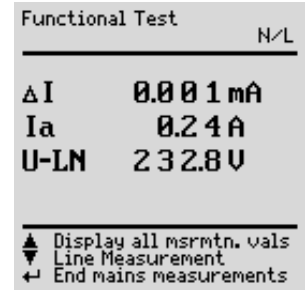
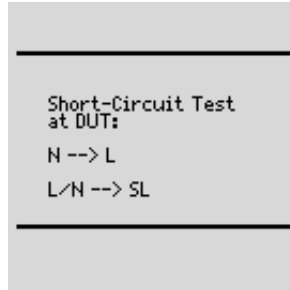

The test socket can be rendered voltage-free with the key (14), or the function test can be ended with the  key (12).



Note

A short-circuit at the device under test is recognized automatically by the test instrument. A message appears at the display (9), and the function test is disabled.

If the  lamp blinks (15), line voltage can be switched to the test socket with the key (14), and the measurement can be started. If the lamp (15) is lit continuously, line voltage is present at the test socket.

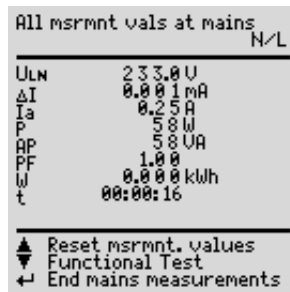

15 Measurements in Accordance with National and International Standards with Selector Switch in Auto Position

If measurements need to be performed in accordance with given standards which require specific tests, and if results need to be stored and documented with a test report, an automatic test sequence is advisable instead of individual measurements.



Note

for tests per EN 60950, EN 61010 and EN 60335

The DUT must be connected to the test socket for the automatic test sequence! The DUT must comply with safety class I or II.

- ⇨ Connect the test instrument to mains power. A **mains connection test** is initialized (see chapter 3.2 on page 12).
- ⇨ Connect the DUT to the test socket at the test instrument (see chapter 7 on page 17). The test instrument initializes **connection type recognition**.
- ⇨ Set the selector switch to the Auto position. If the DUT has been connected to the test socket, **safety class recognition** is performed. Otherwise, the safety class must be specified manually. In the initial program window, move the cursor up with the key into the third line and acknowledge with the key. A safety class can now be selected with the and keys and acknowledged with the key.
- ⇨ In order to select the **regulation** for which testing is to be performed, move the cursor up within the initial program window with the key into the top line and acknowledge with the key. The desired standard can now be selected with the and keys and acknowledged with the key. If you always want to test in accordance with a specific standard, this can be stored as the default standard in the setup menu. Otherwise, the selected standard only remains active until the test instrument is disconnected from mains power (factory default setting: VDE 0701-0702).
- ⇨ The test sequence can be configured in the **Setup...** menu, limit values can be changed if necessary and database options can be configured.
- ⇨ The test sequence is started by selecting **Start test** and by acknowledging with the key (see “Test Sequences”).

Tests which have already been included in chapters 9 through 14 are not described here again. The only exception is measurement of extension cables.

15.1 Test Sequences

Test sequences for the various standards are always run in the same order, assuming that the device under test has been properly connected and the mains connection test has been passed.

The test sequence can be run step by step with manual activation of each subsequent step if this function has been specified, or automatically. Step by step manual operation can be selected in the initial program window in the setup menu under “Sequence” ... “manual sequence”.

- **Safety class:** SC I or SC II is automatically recognized by the test instrument. If the safety class is not correctly recognized, you can change it manually. This manual correction is not stored however.
- **Visual inspection:** If “visual inspection” has been activated in the initial program window under “Sequence”. If a part is recognized as defective by the user, it must be identified as such by selecting it with the cursor and acknowledging with the key.
- **Protective conductor resistance measurement** (for SC I devices under test only)



Note

This test cannot be skipped. Exception:

This measurement can be skipped by pressing (when message „Connect probe to protective conductor“ is displayed) if a protective conductor connection is not possible.

- **Evaluation** of protective conductor testing
- **High-voltage test** for DIN VDE 0701 Part 1, Appendix E, EN 60950, EN 61010, EN 60335, EN 60601, if selected in the setup menu.
- **Insulation resistance measurement**
IEC 62353: only if selected in the setup menu of the initial program window under “Sequence ...”
EN 60601: only if selected in the initial program window under „Test Conditions“
DIN VDE 0701-0702 only if R-INS is activated in the initial program window
- **Evaluation** of insulation test
- **Leakage current measurement** (various single-fault conditions are run depending on classification)
- **Evaluation** of each individual leakage current measurement, see also chapter 21.2
- Evaluation of the overall test

- Perform **function test** if required:
The function test can be performed each time a safety test has been successfully completed. The blinking signal lamp indicates that the function test should be started. Beyond this, the function test can also be started from the **Function Test** selector switch position. See chapter 14 on page 34 regarding performance of the function test.
- Display **test results**
(the worst measured values for the respective test sequence)
- Save test results and print if required

15.2 Setting Up Test Sequences

The order of a test sequence cannot be changed!

However, it is possible to change limit values and measuring parameters, and test steps can be added or skipped.

Principally, two test sequences are distinguished which are described on the following page:

- Sequence 1 (repair tests and periodic tests)
- Sequence 2 (type tests)

Settings for the Test Sequence

Settings for the test sequence are not stored under a type designation, but apply generally for the preset sequence of the respective test standard.

Type-related Settings (Type*) (for tests per EN 60950, EN 61010 and EN 60335 only)

The type-related settings only include limit values. These limit values can be stored for each type under an individual type designation. Measurements the limit values of which have been deleted are skipped.

A type can be stored as default type. This type is indicated if the rotary switch is set to **Auto**.

If no default type has been stored, the following appears for type in the **Auto** rotary switch position: GENERAL and the general limit values of the selected test standard apply.

Overview of adjustable measuring parameters (see chapter 15.3 for their meaning)

Adjustable measuring parameters for test sequences according to standard	DIN VDE 0701 Part 1	DIN VDE 0701 Part 2/40	DIN VDE 0701-0702	DIN EN 60950	DIN EN 61010	DIN EN 60335	IEC 62353	IEC 601/EN 60601	can be stored under
Measuring parameters of the initial program window									
To test socket	•	•	•	•	•	•	•	•	—
Adapter for socket (safety) class	•	•	•	•	•	•	•	•	Test standard
Ext. Cable WITH EL1	•	—	•	—	—	—	—	—	Test standard
Combined Testing	—	•	—	—	—	—	—	—	Test standard
R-INS LN-PE	—	—	•	—	—	—	—	—	Test standard
AP-Type	—	—	—	—	—	—	•	•	Test standard
Limit values	•	•	•	•	•	•	•	•	Test standard (Type)
Type				••	••	••	•	•	Type
Measuring parameters in the Test Cond. menu (test conditions)									
R-INS LN-PE	—	—	—	—	—	—	—	•	Test standard
R-INS AP-PE	—	—	—	—	—	—	—	•	Test standard
HV test	—	—	—	—	—	—	—	•	Test standard
Patient Auxiliary Current	—	—	—	—	—	—	—	•	Test standard
Measuring parameters in the Setup menu									
Visual inspection	•	•	•	•	•	•	•	•	Test standard
Manual sequence	•	•	•	•	•	•	•	•	Test standard
Autostore	•	•	•	•	•	•	•	•	Test standard
Mains polarity reversal	•	•	•	•	•	•	•	•	Test standard
Classification	•	•	•	•	•	•	•	•	Test standard
SK III U _y	•	•	•	•	•	•	•	•	Test standard
R-INS LN-PE	•	•	—	•	•	•	•	—	Test standard
HV test	—	—	—	•	•	•	—	—	Test standard
HV test duration	—	—	—	•	•	•	—	—	Test standard
Auto (test) method	•	•	•	—	—	—	•	—	Test standard
R-PE AC > 10 A	•	—	•	•	•	•	•	•	Test standard
R-PE with clip	—	—	—	—	—	—	—	•	Test standard
No I HL for SC I	—	—	—	—	—	—	—	•	Test standard
Mains wait	•	•	•	•	•	•	•	•	Test standard
First measured values	—	—	—	—	—	—	•	—	Test standard
R-INS AP-PE	—	—	—	—	—	—	•	—	Test standard

See chapter 8 for device parameters in the test sequence

All of the possible sequence settings for all of the regulations are listed below.



Select the **Setup...** menu from the initial program window and acknowledge.

Sequence 1 (repair tests, periodic testing)

store	All of the settings in the setup menu, i.e. the configuration of the measuring parameters and the current limit values can be saved with this command for the selected test standard. These values remain active even after setting the selector switch to a different position, and after disconnection from mains power.
Sequence ...	See page 39.
Limit Values ...	See chapter 4.6 on page 14.
Database ...	Start with ID no. x: Before each measurement is started, an entry prompt appears requesting entry of an ID no. An individual number can be entered (max. 20 characters) with the keypad at the (P)SI module (optional), read in with a barcode scanner (optional) or directly selected from a list. If an incorrect entry is made: Only complete lines can be deleted, and deletion is only possible with the key at the instrument. ID no. = test sequence (Feature KB01 or SECULIFE ST HV). See chapter 16 on page 58.

Additional Parameters

R-PE with clip	x: Protective conductor resistance can be determined with the help of the WZ12C current clip.
High-voltage	x: A high-voltage test is conducted (prerequisite: Feature F02 or SECULIFE ST HV)

Sequence 2 (type tests)

Type:

Limit Values...	Sequences 1 and 2 differ primarily as regards the type parameter. The user can set up any desired type of device under test with sequence 2, for which the same limit values and measuring parameters always apply. Up to 125 different types can be defined. DUT types are predefined for sequence 1 (EN 60601). Designations made up of alphanumeric characters (max. 10 characters) can be entered at the keypad of a (P)SI module, or at a PC with a terminal program. The test sequence, including all limit values, is saved together with the selected type. We recommend using the characters which identify the respective standard as the initial characters in the designation. If a type is queried from the initial program window which does not belong to the currently selected standard, these characters identify the test sequence as belonging to another standard.
Sequence ...	See chapter 4.6 on page 14.
Store as Default	See page 39.
Delete	All of the settings in the setup menu, i.e. the configuration of the measuring parameters and the current limit values can be saved with this command. These values remain active even after setting the selector switch to a different position, and after disconnection from mains power. The type which has been selected in the initial program window can be deleted.

15.3 Configuring Measuring Parameters

Depending upon the test regulation, various measuring parameters can be configured for the test sequence (settings: x / - = function activated / deactivated). All of the possible parameters for all of the regulations are listed below. The **Sequence...** menu is accessed via the setup parameter in the initial program window for the respective regulation.



Select the **Sequence...** menu and acknowledge.



Select a parameter, acknowledge, change and acknowledge the change.

Visual inspection	This menu appears at the very beginning of the test sequence.
Manual sequence	Each test step must be acknowledged with the  key (see test sequence in chapter 8 on page 18 regarding test duration for automatic sequence).
Autostore	After testing is completed, test data are automatically stored to the test instrument (Feature KB01), or in the (P)SI module (accessory).
Mains polarity reversal	L an N are reversed each time line voltage is applied to the test socket.
Classification	Questions regarding classification appear if limit values are exceeded, see chapter 5 on page 15.
SC III U_V	Supply voltage is measured instead of insulation resistance for active devices under test.
R-INS LN-PE	Insulation resistance measurement is performed between phase and neutral conductors, and the protective conductor.
R-INS AP-PE	Insulation resistance measurement is performed from an application part to the protective conductor.

HV test	A high-voltage test is performed (prerequisite: Feature F02 or SECULIFE ST HV)
HV test duration	Duration of a high-voltage test (5 ... 60 s)
Auto (test) method	The instrument recognizes whether or not the device under test can be switched on: Leakage or residual current, or insulation resistance and earth leakage current are measured accordingly.
R-PE AC > 10 A	Protective conductor measurement with 200 mA DC, 10 A AC (feature G00 or SECULIFE ST) oder 25 A AC (feature G01 or SECULIFE ST HV)
R-PE with clip	Protective conductor resistance can be determined with the help of the WZ12C current clip
No I_{HL} for SC I	Contact current is not tested for SC I.
Mains wait	A waiting period between switching mains power on and starting the test can be entered here, e.g. in order to suppress the display of recorded values which occur during warm-up of the device under test.
Patient auxiliary current	Measurement is performed with patient auxiliary current
Adapter for socket	Limit values are activated for permanently connected devices. A device under test which is normally permanently installed can be connected to the test socket via an adapter. No voltage may be applied to the test socket when this test method is used.
First measured values	A menu for the entry of the first measured value appears during the test sequence.

15.4 Testing Devices in Accordance with DIN VDE 0701, Part 1

You can either change over to testing in accordance with the new VDE 0701-0702 standard or perform the following measurements in accordance with the above-mentioned standard:

- Protective conductor measurement R_{PE}
(*permanent connection or with plug*)
 - Part 1: Test current: ± 200 mA DC
 - Appendices: Test current: 10 A AC (Feature G00 or **SECULIFE ST**)
Test current: 25 A AC (Feature G01 or **SECULIFE ST HV**)
- High-voltage test as supplement (Appendix E)
(Prerequisite: Feature F02 or **SECULIFE ST HV**)
- Insulation resistance measurement R_{INS}

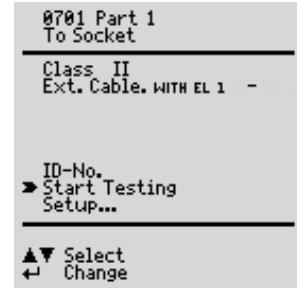

Part 1

The following safety class I through III appliances and electric equipment can be tested with this standard, for example:

- Devices with electric motors
- Electric heating devices
- Electric tools
- Light fixtures
- Stereo equipment, television sets

SC I extension cables can also be tested (see chapter 15.7 on page 46).

Appendices (previously part 260)

Appendix E: Electric tools

Check connection parameters and start test.

To Socket

This is the default setting. Refer to chapter 7 on page 17 for other types of connection.

Class

If the DUT has been connected to the test socket, safety class recognition is performed (SC I or SC II). Otherwise, the safety class must be specified manually.

Ext. Cable WITH EL1

x: Extension cables or connector cables which are longer than 5 m can be tested with the help of the EL1 adapter (optional), either separately or in combination with a device, see chapter 15.7.

ID No.

See parameters database in chapter 15.2 on page 37.

Setup...

See chapter 15.2 on page 37 regarding setup of the measuring sequence.



Note

Extension cables can only be tested with the VDE 0701-0702 (VDE 0701 part 1) parameter settings, if the EL1 accessory adapter is used (see chapter 15.7 on page 46).

Test Sequence per VDE 0701

Select connection, select test regulation **VDE 0701 part 1**, classify DUT (SC I, II or III), **part 1: extension cable X/- (with/without), Appendix E: HV test X/- (with/without)**

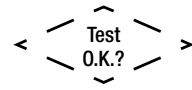
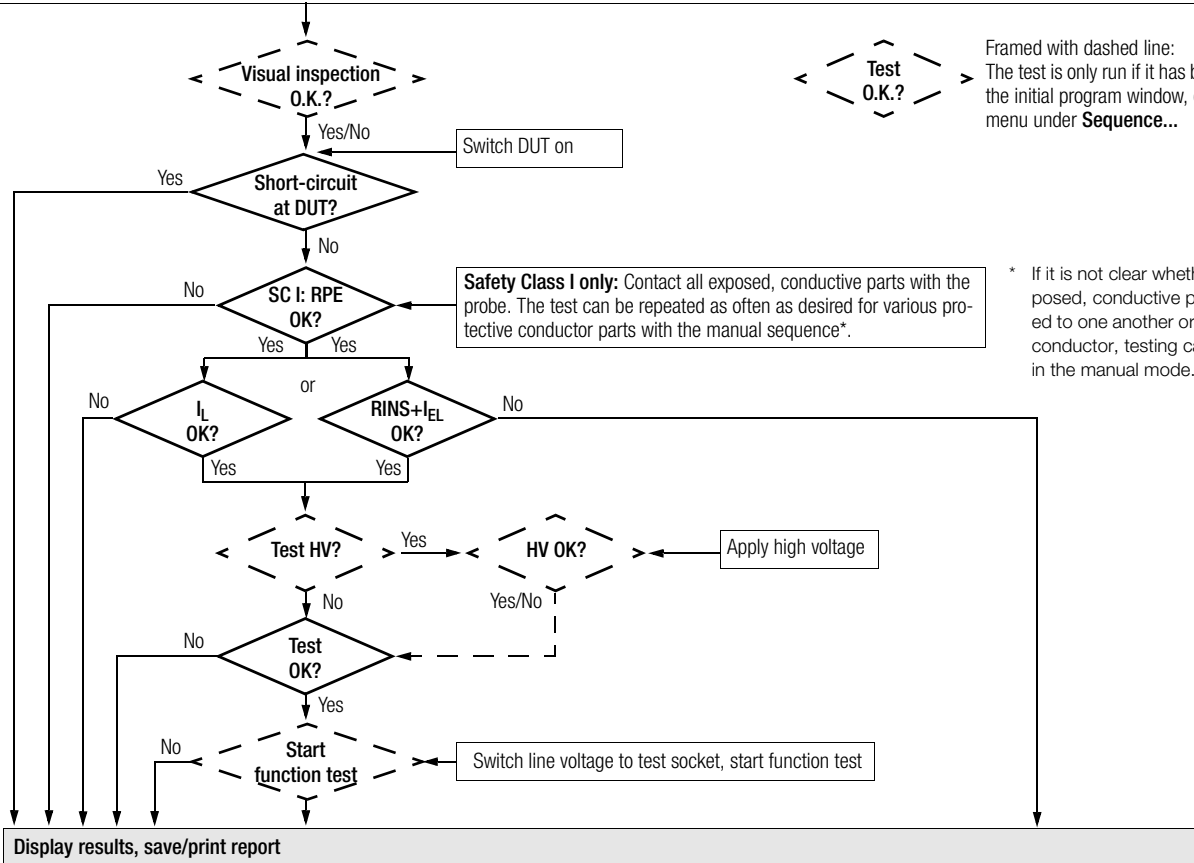

Framed with dashed line:
The test is only run if it has been activated in the initial program window, or in the **Setup** menu under **Sequence...**

Safety Class I only: Contact all exposed, conductive parts with the probe. The test can be repeated as often as desired for various protective conductor parts with the manual sequence*.

* If it is not clear whether or not all exposed, conductive parts are connected to one another or to the protective conductor, testing can be performed in the manual mode.

15.5 Testing Devices in Accordance with DIN VDE 0701, part 240

You can either change over to testing in accordance with the new VDE 0701-0702 standard or perform the following measurements in accordance with the above-mentioned standard:

Testing safety class I and II **data processing equipment and office machines** as individual devices and in combination with one another.

The following measurements can be performed in accordance with the above mentioned standard:

- Protective conductor R_{PE} (*permanent connection or with plug*)
Test current: DC ± 200 mA
- Contact current I_{Σ}
- According to DIN VDE 0701, part 240, the device protective conductor must be tested after maintenance, repair or modification of data processing equipment and office machines, and exposed, conductive parts must be tested for the absence of voltage. This applies to:
 - Safety class I devices for all exposed, conductive parts which are accessible to the user, and which are not connected to the protective conductor
 - Safety class II devices (totally insulated devices) for all exposed, conductive parts which are accessible to the user

with the mains plug poled in both directions.

Setting Up the Test Sequence

See chapter 15.4 regarding the test sequence.

Special Parameters

Combined Testing

Safety class I and II devices can be tested individually or in combination. All protective conductor connections are tested first for interconnected safety class I devices, and then – as is also the case for interconnected safety class II devices – all exposed, conductive parts.

Connecting the Device Under Test

- ⇨ Connect the test instrument and the DUT as described below:
 - Connect both devices to separate mains outlets.
The outlets to which the test instrument and the safety class I DUT are connected must share a common protective conductor!
 - Or connect the test instrument to the mains and the DUT to the test socket at the test instrument.

Data Processing / Office Machines

Permanently connected or with plug

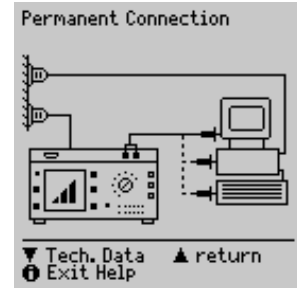

To test socket at the instrument

The requirement for **testing with the mains plug poled in both directions** can be fulfilled by connecting the DUT to the test socket at the instrument, and by activating mains polarity reversal in the setup menu under “Sequence”. Each time the key (14) is activated, phase conductor L and neutral conductor N are reversed at the test socket.

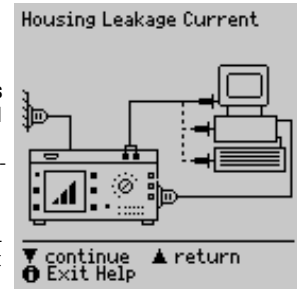

Attention!

Testing with mains polarity reversal or with the mains plug poled in both directions results in interruption of supply power to the affected data processing equipment or office machine. This test may thus only be conducted with the consent of the operator of the data processing equipment or office machine.

If the DUT is defective, the electrical system's RCCB may be tripped during testing which would also result in interruption of supply power to the affected equipment or office machine. The manufacturer of the test instrument assumes no liability for the loss of data or other damage which result from use of the test instrument.

Test Sequence per VDE 0701, part 240

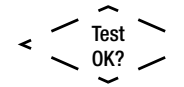
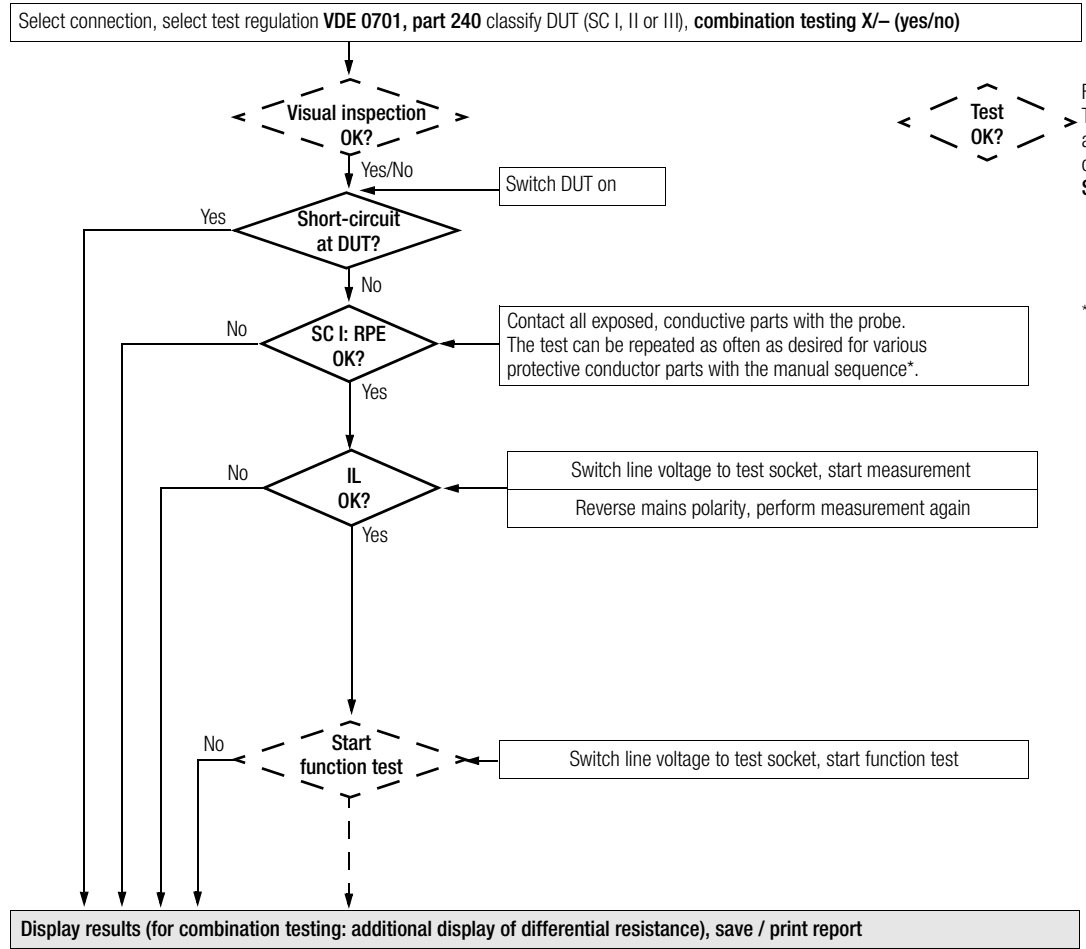

Framed with dashed line:
The test is only run if it has been activated in the initial program window, or in the **Setup** menu under **Sequence....**

* If it is not clear whether or not all exposed, conductive parts are connected to one another or to the protective conductor, testing can be performed in the manual mode.

15.6 Testing Devices in Accordance with DIN VDE 0701-0702:2008

The following measurements can be performed in accordance with the above mentioned standard:

- Protective conductor R_{PE} (*permanent connection or with plug*)
Test current: DC ± 200 mA
Test current: 10 A AC (Feature G00 or **SECULIFE ST**)
Test current: 25 A AC (Feature G01 or **SECULIFE ST HV**)
- Insulation measurement R_{INS} (*can be deactivated, e.g. if danger exists that voltage sensitive components in data processing systems might be damaged*) plus equivalent leakage current

or

- Contact current for safety class II

or

- Residual current

Check connection parameters and start test.

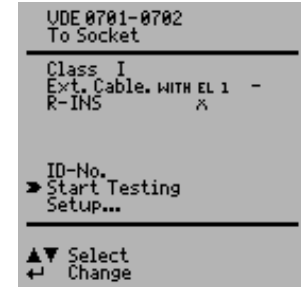

To Socket	This is the default setting. Refer to chapter 7 on page 17 for other types of connection.
Class	If the DUT has been connected to the test socket, safety class recognition is performed (SC I or SC II). Otherwise, the safety class must be specified manually.
Ext. Cable WITH EL1	x: Extension cables or connector cables which are longer than 5 m can be tested with the help of the EL1 adapter (optional), either separately or in combination with a device, see chapter 15.7.
R-INS LN-SL	x: Insulation resistance measurement is performed.
ID No.	See parameters database in chapter 15.2 on page 37.
Setup...	See chapter 15.2 on page 37 regarding setup of the measuring sequence.

Test Sequence per DIN VDE 0701-0702:2008

Select connection, select test standard **VDE 0701-0702**, classify DUT (SC I, II or III), **extension cable X/- (with/without)**

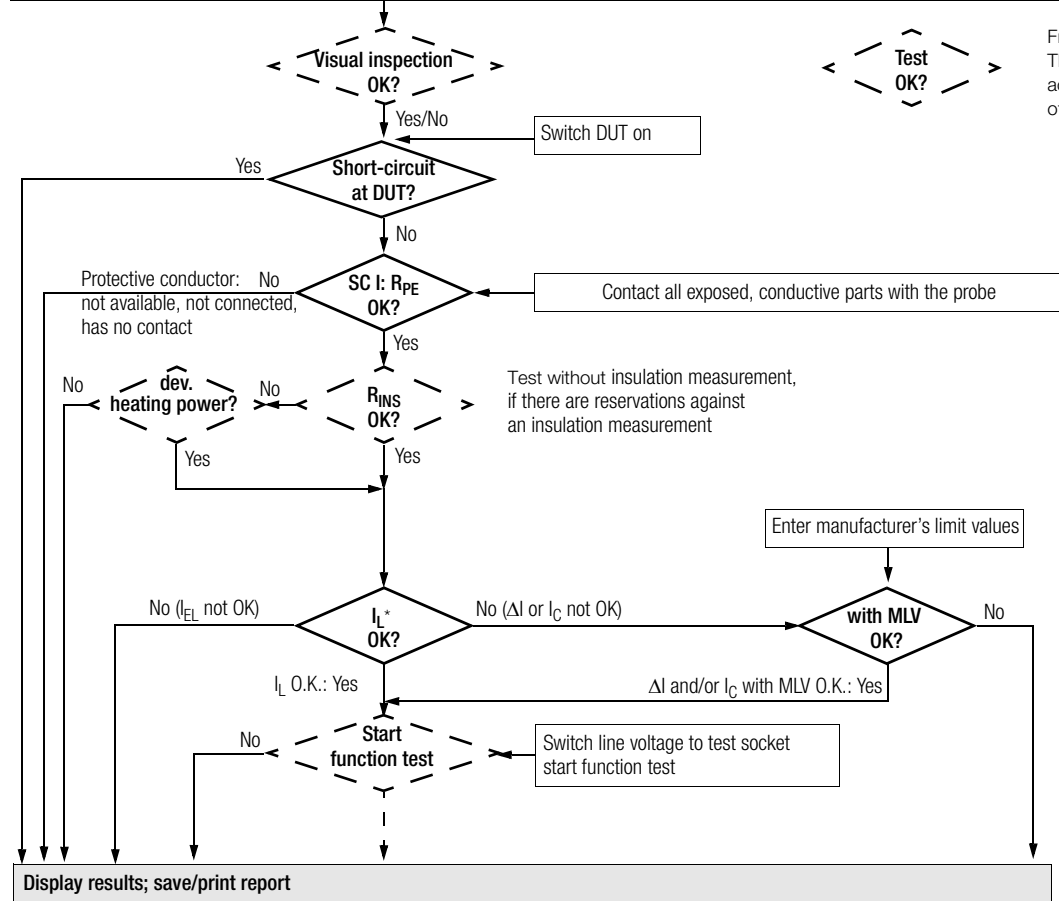

Framed with dashed line:
The test is only run if it has been activated in the initial program window of in the **Setup** menu under **Sequence ...**

* • Equivalent leakage current I_{EA}
• Residual current ΔI and contact current (direct) I_B

15.7 Testing Extension Cables for VDE 0701-0702 (VDE 0701 Part 1) (optional EL1 adapter)

Extension Cables up to 5 m Long

Protective conductor resistance between the earthing contact at the mains plug and all exposed metal parts may not exceed 0.3Ω for safety class I devices. This value may not exceed 1Ω for permanently connected data processing systems (DIN VDE 0701, part 240).

Extension and Connector Cables Longer than 5 m

An additional cable resistance of 0.1Ω , however, not more than 1Ω , is allowable as of a length of 5 m for each additional 7.5 m.

Resistance testing for cables longer than 5 m is thus advisable (see also limit values on page 20).



Note

The EL1 accessory adapter is required for testing for short-circuiting and interruption of single-phase extension cables.

Connecting the Extension Cable or the Multiple Outlet

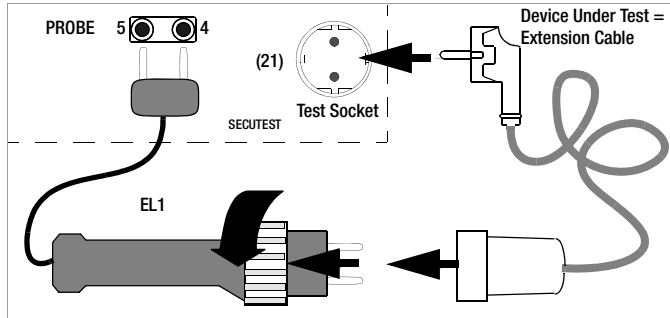

Note

The keys in the adapter's handle have no function.

Performing the Test

- ⇨ Connect the extension cable to the EL1 adapter as shown in the figure above.
- ⇨ Select the "Ext. Cable WITH EL1" test from the initial menu with the cursor and acknowledge with the \square key: x.
- ⇨ Select "Start Testing" with the ∇ key.
- ⇨ Start the test sequence with the \square key.
- ⇨ First perform and acknowledge visual inspection of the extension cable.
- ⇨ Enter the length of the cable with the Δ and ∇ keys. Acknowledge with the \square key.

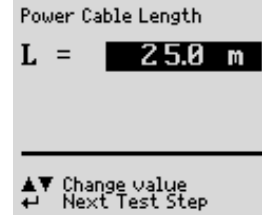

For conductors with a rated current of $> 16 \text{ A}$, the cross section (Diameter) has to be taken into account during measurement.

The cross section is only queried if a 3-phase current adapter has been connected and the connection parameter has been set to VL2E or AT3-III.E. Upon entering the cross section, the limit value for the protective conductor resistance is recalculated.

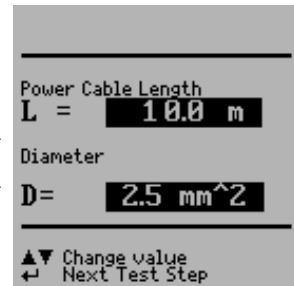

15.8 Testing Multiple Outlets for VDE 0701-0702 (optional EL1 adapter)

- ⇨ Select “Ext. Cable WITH EL1” in the initial menu. The following must appear in the line: “Ext. Cable WITH EL1 x”. “Manual sequence” must be selected.
- ⇨ A visual inspection must always be performed. It may thus be necessary to unreel the cable from its drum or reel.
- ⇨ Protective conductor resistance measurement: Contact the first outlet with the EL1 adapter. Each time you are ready to contact the next outlet, press the  key to repeat the test.

15.9 Testing in Accordance with DIN EN 60950

Tests for safety class I and II **data processing equipment and office machines**.

The following measurements can be performed in accordance with the above mentioned standard:

- Protective conductor R_{PE}
Test current: : 25 A AC(Feature G01 or **SECULIFE ST HV**)
- Testing of dielectric strength by applying DC high voltage (1.5-fold value)
(Prerequisite: Feature F02 or **SECULIFE ST HV**)
- Contact current I_c

According to DIN EN 60950, data processing equipment and office machines must be subjected to a device protective conductor test and a high-voltage test before they are brought into circulation. This applies to:

- Safety class I devices for all exposed, conductive parts which are accessible to the user, and which are not connected to the protective conductor
 - Safety class II devices (totally insulated devices) for all exposed, conductive parts which are accessible to the user
 - Contact current
- with the mains plug poled in both directions

Connecting the Device Under Test

- ⇔ Connect the test instrument to the mains, and the device under test to the test socket at the test instrument.

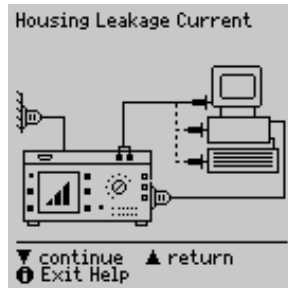

Check connection parameters and start test.

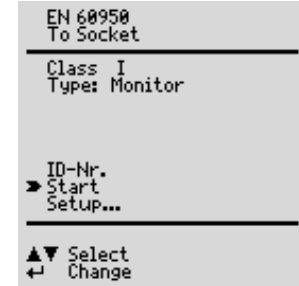
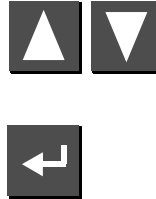

To Socket

This is the default setting. Refer to chapter 7 on page 17 for other types of connection.

Class

If the DUT has been connected to the test socket, safety class recognition is performed (SC I or SC II). Otherwise, the safety class must be specified manually.

Type

A specific DUT type can be selected from a list of devices under test, if these have been entered in the setup menu.

ID No.

An individual serial number (up to 10 characters) can be entered with the keypad at the (P)SI module (accessory), or can be read in with a barcode scanner (accessory).

If an incorrect entry is made: Only complete lines can be deleted, and deletion is only possible with the key at the instrument.

Setup...

Refer to chapter 15.2 on page 37 regarding setup of the measuring sequence.

Test Sequence per EN 60950

Select connection, select test regulation **EN 60950** classify DUT (SC I, II or III), setup/sequence: **R-INS / HV test X/- (with/without)**

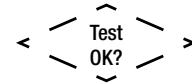
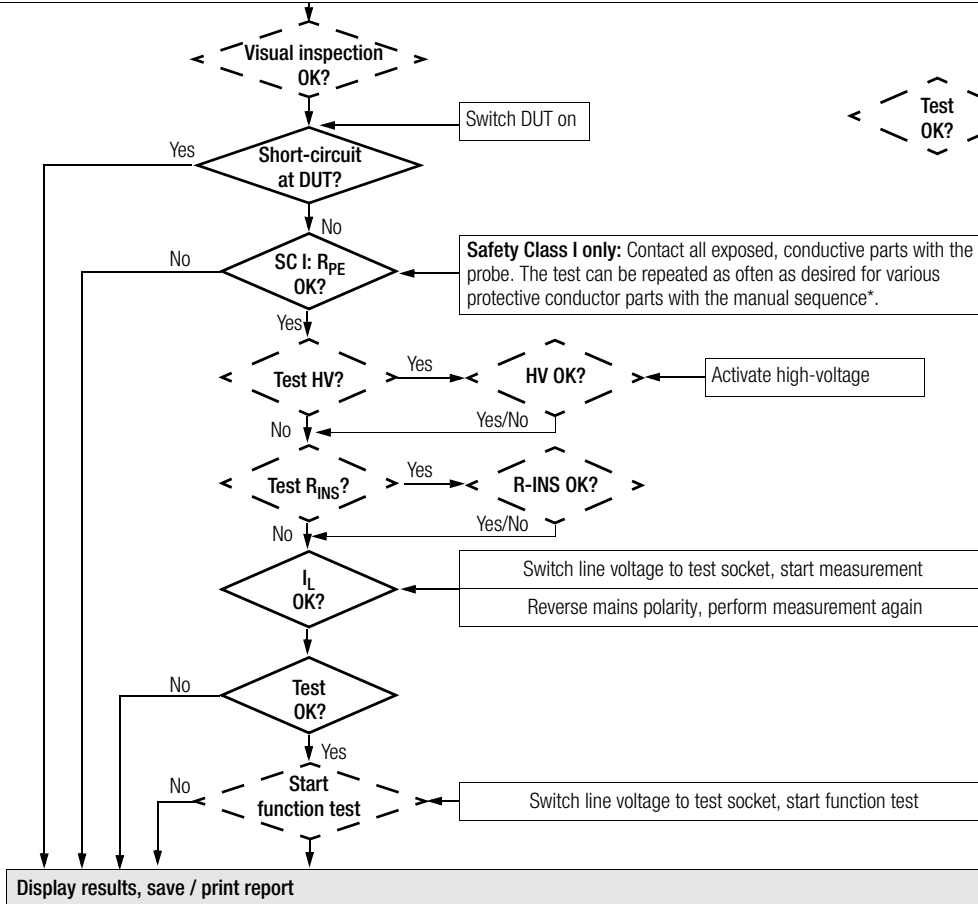

Framed with dashed line:
The test is only run if it has been activated in the **Setup** menu under **Sequence...**

* If it is not clear whether or not all exposed, conductive parts are connected to one another or to the protective conductor, testing can be performed in the manual mode.

15.10 Testing Devices in Accordance with EN 61010

The following measurements can be performed in accordance with the above mentioned standard. Connection must be made via the test socket:

- Protective conductor R_{PE}
Test current: 10 A AC (Feature G00 or **SECULIFE ST**)
Test current: 25 A AC (Feature G01 or **SECULIFE ST HV**)
- Testing of dielectric strength by applying high voltage with direct voltage (1.5-fold value)
(Prerequisite: Feature F02 or **SECULIFE ST HV**)
- Insulation measurement R_{INS} (*can be deactivated*)
- Contact current under normal condition $I_{HL,NC}$ and single-fault condition $I_{HL,SF}$ with interrupted protective conductor

Check connection parameters and start test.

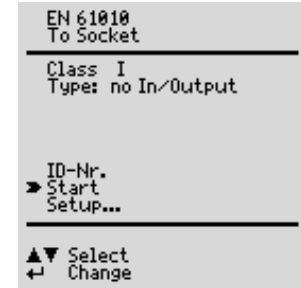

To Socket	This is the default setting. Refer to chapter 7 on page 17 for other types of connection.
Class	If the DUT has been connected to the test socket, safety class recognition is performed (SC I or SC II). Otherwise, the safety class must be specified manually.
Type	A specific DUT type can be selected from a list of devices under test, if these have been entered in the setup menu.
ID No.	An individual serial number (up to 10 characters) can be entered with the keypad at the (P)SI module (accessory), or can be read in with a barcode scanner (accessory). If an incorrect entry is made: Only complete line can be deleted, and deletion is only possible with the  key at the instrument.
Setup...	Refer to chapter 15.2 on page 37 regarding setup of the measuring sequence.

Test Sequence per EN 61010

Select connection, select test standard **EN 61010**, classify DUT (SC I, II or III), setup/sequence: **R-INS-/HV test X/- (with/without)**

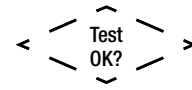
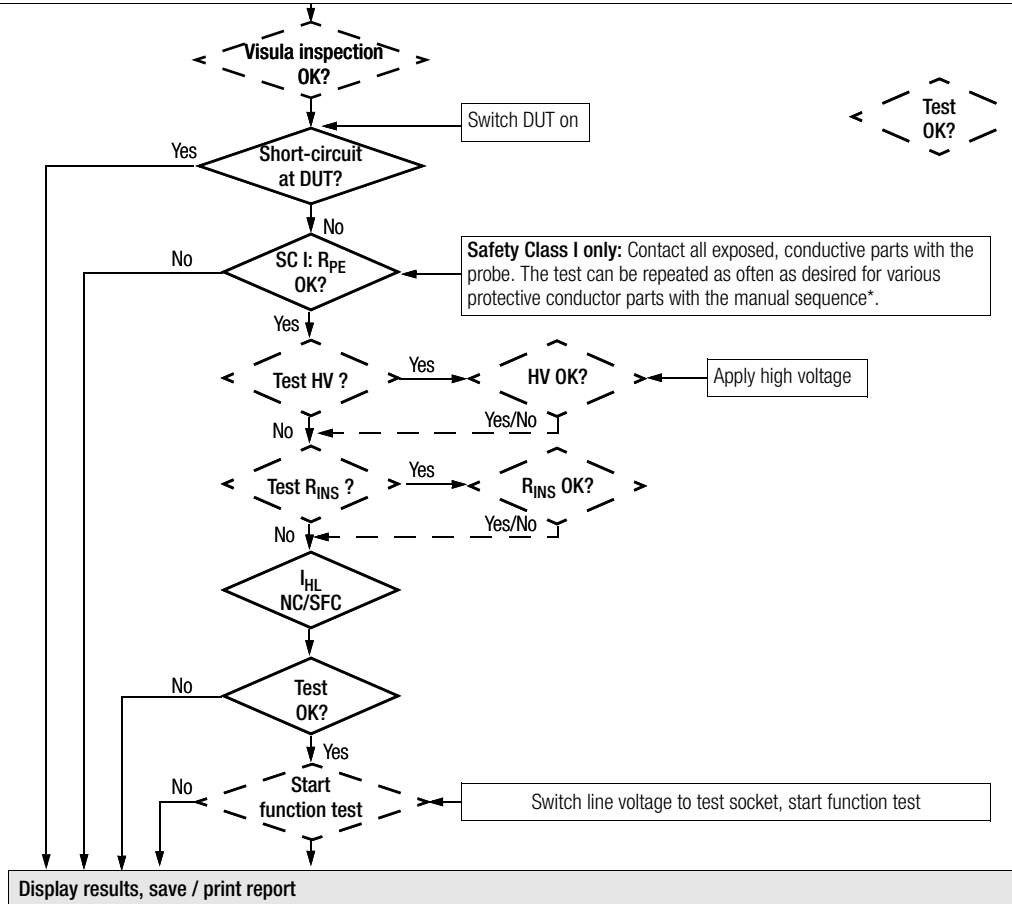

Framed with dashed line:
The test is only run if it has been activated in the **Setup** menu under **Sequence....**

15.11 Testing Devices in Accordance with EN 60335

The following tests can be performed in accordance with VDE 0700, part 500, (as part of DIN EN 50106:1998) in compliance with special rules for routine testing of devices for which EN 60335-1 and EN 60967 apply:

- Testing of the protective conductor connection by means of resistance measurement R_{PE} (*permanent connection or with plug*)
Test current: 10 A AC (Feature G00 or **SECULIFE ST**)
Test current: 25 A AC (Feature G01 or **SECULIFE ST HV**)
- Testing for dielectric strength by applying DC high-voltage (1.5-fold value) (Prerequisite: Feature F02 or **SECULIFE ST HV**)
- Function test

The following tests can be performed in accordance with EN 60335-1:1994:

- Testing for dielectric strength by applying high-voltage (Prerequisite: Feature F02 or **SECULIFE ST HV**)
- Testing for Equivalent Leakage Current

Additional testing options:

- Insulation resistance measurement R_{INS}
- Residual current

Check connection parameters and start test.

If desired, the test sequence can be adapted to the respective device under test in the following menu in **Setup...** under **Sequence....**

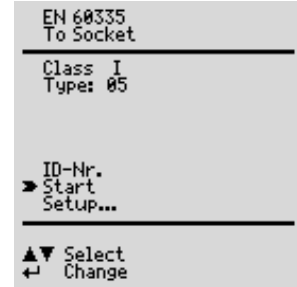

To Socket	This is the default setting. Refer to chapter 7 on page 17 for other types of connection.
Class	If the DUT has been connected to the test socket, safety class recognition is performed (SC I or SC II). Otherwise, the safety class must be specified manually.
Type	A specific DUT type can be selected from a list of devices under test, if these have been entered in the setup menu.
ID No.	An individual serial number (up to 10 characters) can be entered with the keypad at the (P)SI module (accessory), or can be read in with a barcode scanner (accessory). If an incorrect entry is made: Only complete line can be deleted, and deletion is only possible with the  key at the instrument.
Setup...	Refer to chapter 15.2 on page 37 regarding setup of the measuring sequence.

Test Sequence per EN 60335

Select connection, select test regulation **EN 60335** classify DUT (SC I, II or III), setup/sequence: **R-INS / HV test X/- (with/without)**

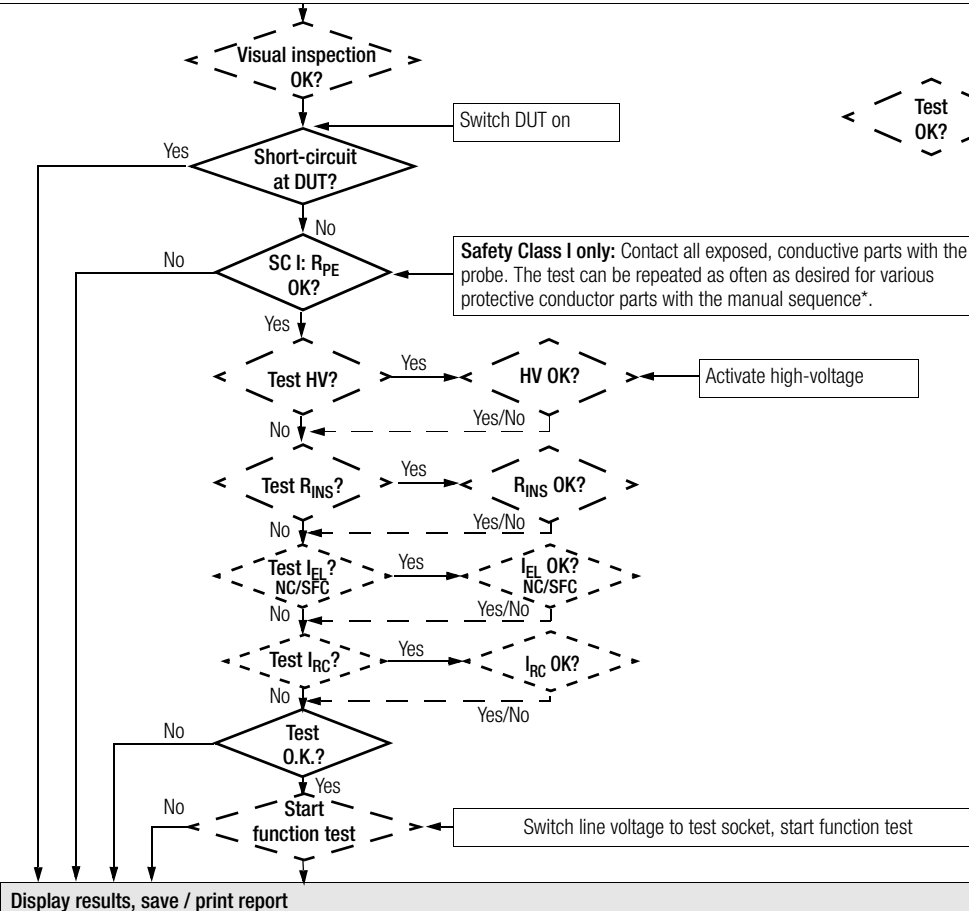

15.12 Testing in Accordance with IEC 62353/VDE 0751

The following measurements can be performed in accordance with the above mentioned standard:

- Protective conductor measurement R_{PE}
Test current: 200 mA DC,
Test current: 10 A AC (Feature G00 or **SECULIFE ST**)
Test current: 25 A AC (Feature G01 or **SECULIFE ST HV**)
- Insulation measurement (*can be additionally activated*)
 - R-INS LN-PE (insulation resistance, LN to protective conductor)
 - R-INS AP-PE (insulation resistance, app. part to protective conductor)
- Equivalent device leakage current I_{EDL}
- Equivalent patient leakage current I_{EPL}
- Device leakage current (direct or residual current)
- Contact current
- Patient leakage current
(direct or mains at application part)

Leakage current is converted to reference voltage (see limit values chapter 8 on page 18). Reference voltage must be adapted to the supply voltage range.

Check connection parameters and start test.

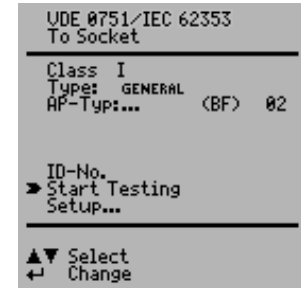

To Socket	This is the default setting. Refer to chapter 7 on page 17 for other types of connection.
Class	If the DUT has been connected to the test socket, safety class recognition is performed (SC I or SC II). In all other cases, or if it is not clear whether or not all exposed, conductive parts are connected to one another or to the protective conductor, the safety class can be selected manually.
Type	Select the device type (DUT) from the list. If “old devices” is selected, limit values from DIN VDE 0701-0702 are used.
AP-Type:...	(BF): Application parts are recognized automatically, and can be manually changed as well: Select the App. prt. ... line with the or key, acknowledge with the key and change with the or key. 02 : The number of configured groups is displayed here. After selecting the App. prt. ... line with the or key, acknowledging twice with the key and then pressing the or key, the “Configure application parts” menu appears (see chapter 15.13 on page 56).
ID No.	See parameters database in chapter 15.2 on page 37.
Setup...	Refer to chapter 15.2 on page 37 regarding setup of the measuring sequence.

Test Sequence per IEC 62353/VDE 0751

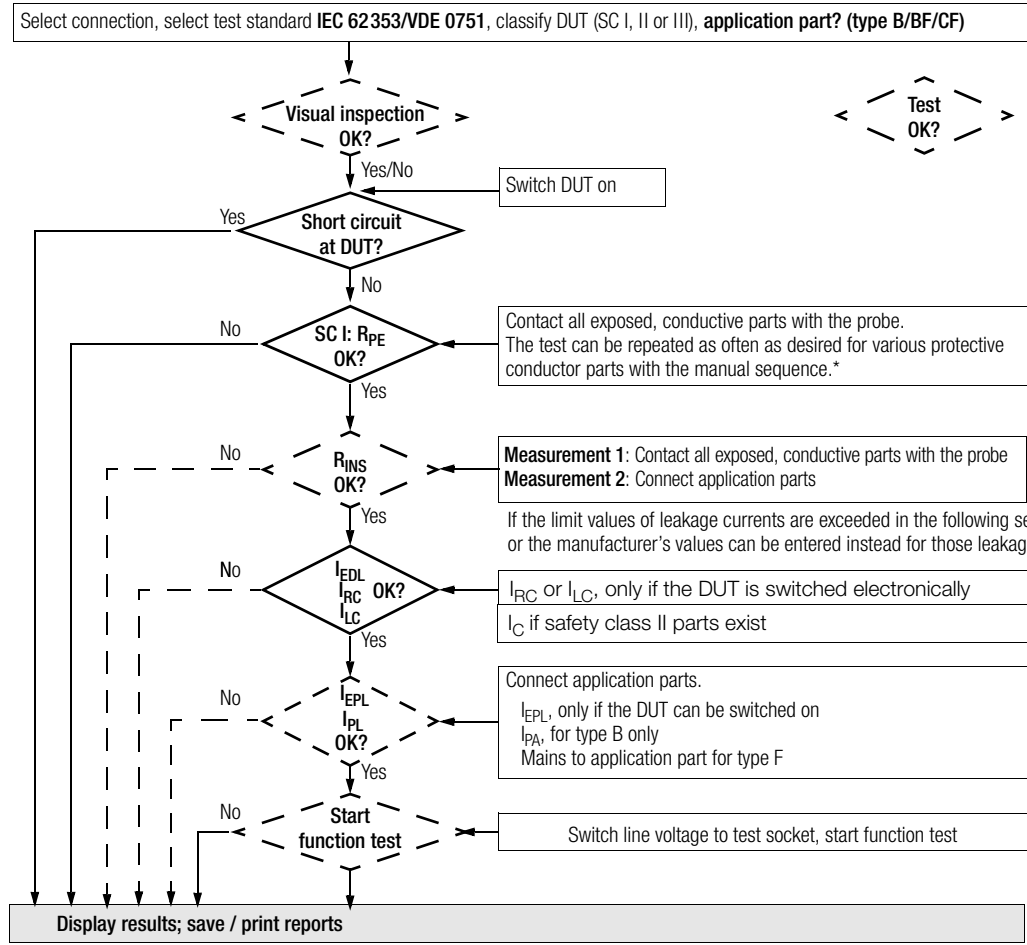

Framed with dashed line:
 The test is only run,
 – if it has been activated in the initial program window, or in the **Setup** menu under **Sequence**
 or
 – if possible at all

Contact all exposed, conductive parts with the probe. The test can be repeated as often as desired for various protective conductor parts with the manual sequence.*

Measurement 1: Contact all exposed, conductive parts with the probe
Measurement 2: Connect application parts

If the limit values of leakage currents are exceeded in the following sequence, the first measured values or the manufacturer's values can be entered instead for those leakage currents which did not pass.

I_{RC} or I_{LC} , only if the DUT is switched electronically
 I_C if safety class II parts exist

Connect application parts.
 I_{EPL} , only if the DUT can be switched on
 I_{PA} , for type B only
 Mains to application part for type F

Switch line voltage to test socket, start function test

* If it is not clear whether or not all exposed, conductive parts are connected to one another or to the protective conductor, testing can be performed in the manual mode.

15.13 Testing in Accordance with EN 60601 (Feature KA01)

The following leakage and auxiliary currents can be measured in accordance with the above mentioned standard in the operating mode, as well as under normal and single-fault conditions:

- Protective conductor measurement R_{PE}
test current: 10 A AC (Feature G00 or **SECULIFE ST**)
Test current: 25 A AC (Feature G01 or **SECULIFE ST HV**)
- Earth leakage current I_{PE}
- Contact current I_{HL}
- Patient leakage current I_{PL} (with nominal voltage at application part)
- Patient auxiliary current I_{PA}

Leakage current is converted to reference voltage (see limit values chapter 8 on page 18). Reference voltage must be adapted to the supply voltage range.

Check connection parameters and start test.

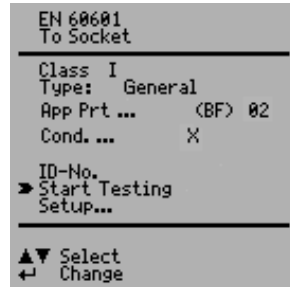

To

Test Socket This is the default setting. For other connection types, please refer to chapter 7 on page 17.

Class If the DUT has been connected to the test socket, safety class recognition is performed (SC I or SC II). In all other cases, or if it is not clear whether or not all exposed, conductive parts are connected to one another or to the protective conductor, the safety class can be selected manually.

Type	The DUT type can be selected from a list. If the limit values of the 3rd issue are to be taken into account, select a DUT type ending with ... 3rd under this parameter.
Cond.	Various test conditions can be activated here, including insulation resistance measurement.
App Prt...	See below and on page 54.
ID-No.	See parameters database in chapter 15.2 on page 37.
Setup...	Refer to chapter 15.2 on page 37 regarding setup of the measuring sequence.

Configure Application Parts

Entry is made here indicating whether or not the application parts are to be tested. Jacks A through K (for connection of cables or probes) can also be assigned to groups (application parts) for mutual testing.

Selecting Preset Test Combinations

- ⇨ Use the cursor to select test combinations with groups of 1, 2, 5 or 10 application parts and acknowledge with the key.
The groups are assigned automatically after the application parts have been selected.

Selecting User Defined Test Combinations

- ⇨ Select the respective application part from the JACK column with the cursor and acknowledge with the key. You can set up a user defined group for each application part which includes 1 to 10 application parts with the cursor keys in the GR column (GRoup). Acknowledge your settings with the key.

As long as at least one group number has been entered, the application parts test is preset in the "To Socket" window.

The application part type with the strictest limit value takes precedence in the initial window. All groups are set to this type. Various types can be assigned to the groups with "direct print" (adjustable option in the setup menu).

If testing is not to be performed with application parts, the group assignment must be cancelled with the "clear" function.

The TYPE is filled in automatically if the safety class has already been entered to the "To Socket" window.

Flowchart, see next page.

Select connection, select test regulation **EN 60601** classify DUT (SC I, II or III), test conditions (amongst others R_{INS} measurement), **application part? (type B/BF/CF)**

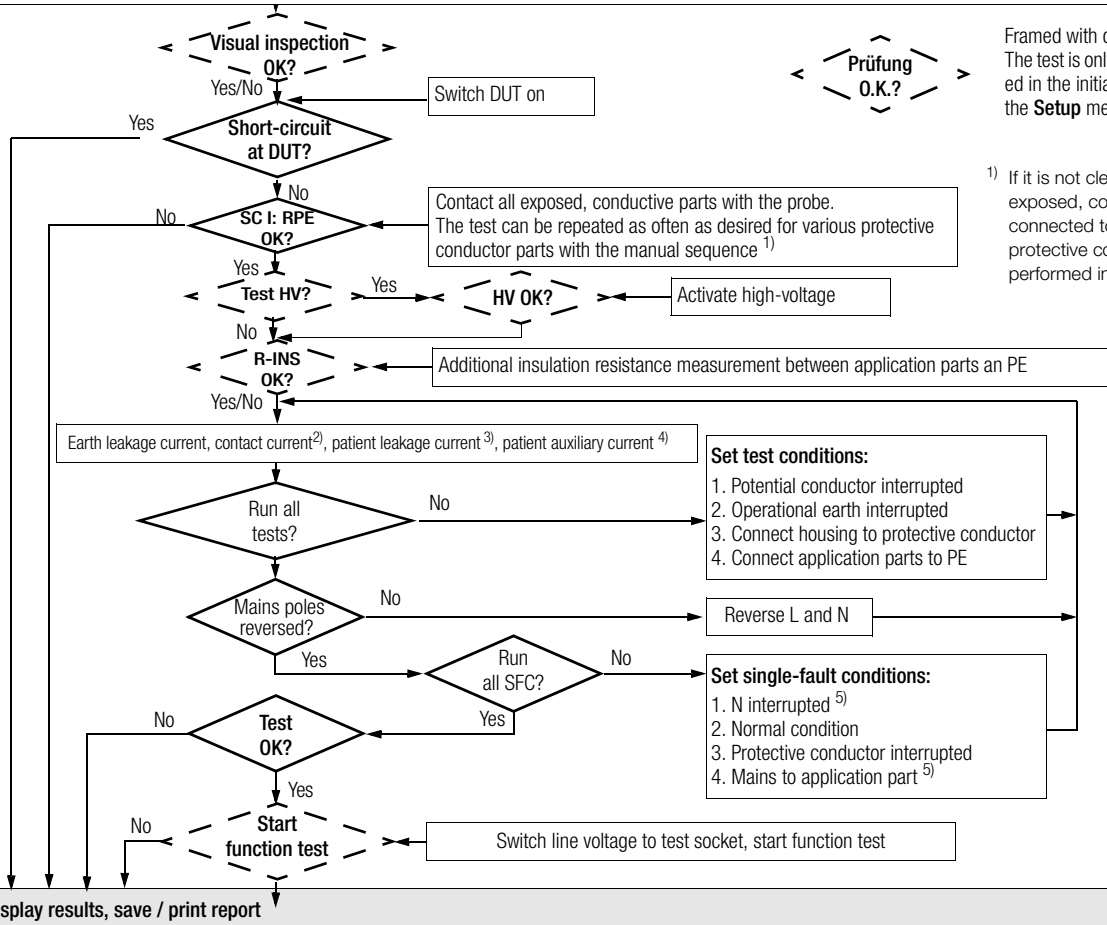

Prüfung O.K.?

Framed with dashed line:
The test is only run if it has been activated in the initial program window, or in the **Setup** menu under **Sequence...**

1) If it is not clear whether or not all exposed, conductive parts are connected to one another or to the protective conductor, testing can be performed in the manual mode.

- 2) no N interrupted
- 3) Test is only performed if at least one type BF or CF application part is connected.
- 4) Test is only performed if at least two type BF or CF application parts are connected
- 5) Test method: equivalent leakage current

16 Storing in (P)SI Module (Accessory) and Database Operations (Feature KB01)

16.1 Storing Measurement Data in the (P)SI Module

Upon completion of a measurement – message „Test passed/failed“ is displayed – you can file the measurement data in the memory of the (P)SI module.

- ⇨ Press the **STORE** key at the (P)SI module.
A text entry field is displayed.
- ⇨ You may now enter your comments on the measurement and/or an ident. no.
- ⇨ Press the **STORE** key once more in order to save the measurement data and your comments.
The message: „Data are being stored“ is shown on the display.

A detailed description is included in the operating instructions for your (P)SI module in the chapter „Display, print and store protocol“.

16.2 Database Operations

16.2.1 Storing Test Results to the Test Instrument

If no (P)SI module has been connected, up to 125 reports can be stored to the test instrument (without function test values and without comments on DUT). The reports can be viewed as required at the instrument and can be printed out, for example with the help of a terminal program, see chapter 18.



The reports are sorted by time and date and are displayed with the ID number. If no ID number was assigned, date and time are automatically saved instead.

As an alternative, consecutive numbering can be selected.

16.2.2 Uploading Report Templates into Test Instrument, Reading Out From the Test Instrument, Editing at the PC and Re-Saving to the Test Instrument

The „Test result“ menu allows for storage of up to 4 **report templates** in the test instrument. Report templates are uploaded from a file at a PC to the test instrument (“Load file”). Templates can also be uploaded from the test instrument to a PC (“Templates from Secutest”), and then edited and re-saved.

After completion of a test (“Passed” or “Failed” appears at the instrument’s LCD), the test results are read out to one of these report templates

in the form of **report data** (depending upon the selector switch position or test regulation) via the RS 232 interface. The report menu in the test instrument is activated with the  and  keys to this end. In order to read out the report data at a PC, it is necessary to connect the SECUSTORE storage adapter with the RS232 interface. The report can, for example, be displayed with the PC analysis program WinProfi (as from version 3.06) or ETC (as from version 1.22).

16.2.3 Reading Out and Saving Test Results / Test Data from the (P)SI Module

Test results saved to the test instrument can be displayed, edited, printed (only PSI module) or saved after reading them into a PC using the desired report template.

Data can be processed immediately after completion of the test, or from the database (Feature KB01). Data can be saved with or without a report template (e.g. for further processing with PS3).

Test results saved to the (P)SI module can also be read out, printed (only PSI module), saved or processed by means of a report template.

Easy method of printing out reports:

Activate the „test result“ menu in the update and options installation program. When the test result is displayed in the test instrument select the print function (press key „Cursor up“, then set the cursor on „print“ and press ENTER).

17 Recognition of Probe to Protective Conductor (Feature KD01)

The protective conductor measurement is expanded to include the function: “automatic recognition of measuring point change”. During protective conductor measurement, the instrument recognizes whether or not the probe is in contact with the protective conductor, and indicates these two possible conditions by means of acoustic signals.

This function is helpful if several protective conductor connections need to be tested. The function can be activated in the “test sequence setup” menu with “auto measuring point” (see “changes to the switch position menu” above).

18 Storing Test Results and Printing in Report Form

You can shift to the **Protocol** menu from any of the displayed test results (1st page) with the help of the **▲** key.

	MERS. VALUES	LIMITS
RPE	0.315 Ω	<1.000 Ω
RINS	2.00 MΩ	>1.000 MΩ
UINS	523 U	500 U
IeHL	0.115 mA	<3.500 mA

Passed!

← New ▲▼ Page Ⓞ Fnc.

Storing to the Test Instrument

Measurement results for the current test can be stored to the test instrument, the results of the current test can be printed out to the corresponding report form, previously stored test results can be queried (scroll: Feature KB01, see chapter 16) and all stored measurement results can be read out from this menu.

The report template automatically complies with the standard of the selected switch position, provided that parameter „Select template“ has been deactivated.

If parameter „Select template“ is activated, it is possible to select one of 5 different report templates. Templates 1 to 4 can be modified via the update and options installation program SECU-Up, see chapter 16.2.2.

Storing to the SECUSTORE Storage Adapter (Accessory)

Connect the SECUSTORE storage adapter with the test instrument via the RS232 interface. The (P)SI module may not be connected.

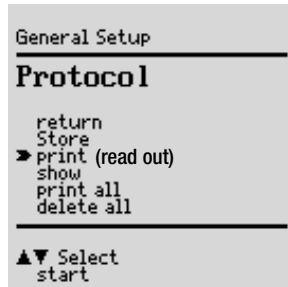

Direct Print-Out (Feature KE01 in Combination with a PSI Module or SECUSTORE Storage Adapter)

After completion of each test (individual test or at the end of a test sequence), test results are read out directly via the RS232 interface.

When the PSI module is connected (accessory, not part of the standard equipment), the result is directly printed on paper. When the SECUSTORE storage adapter is connected, the test result is stored to the SECUSTORE memory.

In this operating mode, no results can be saved to the internal memory or to the (P)SI module.

Item	Value	Limit
VDE 0751	allgemein	SK I
1 R-SL	+0.044 Ω	<0.300 Ω
EGA	+0.942 mA	<0.898 mA
EPA AB (BF)	+000.0 μA	<04.49 mA
EPA CD (BF)	+000.3 μA	<04.49 mA
EPA EF (BF)	+000.2 μA	<04.49 mA
EPA GH (BF)	+000.3 μA	<04.49 mA
EPA IK (BF)	+000.2 μA	<04.49 mA
VDE 0751	allgemein	SK I
1 R-SL	+0.043 Ω	<0.300 Ω
DI	+1.029 mA#	<0.449 mA
Netz am Anw.Teil		
PA-NAT AB (BF)	+000.6 μA	<05.00 mA
PA-NAT CD (BF)	+000.6 μA	<05.00 mA
PA-NAT EF (BF)	+000.6 μA	<05.00 mA
PA-NAT GH (BF)	+000.6 μA	<05.00 mA
PA-NAT IK (BF)	+000.6 μA	<05.00 mA
L/N		
DI	+1.031 mA#	<0.449 mA
Netz am Anw.Teil		
PA-NAT AB (BF)	+000.6 μA	<05.00 mA
PA-NAT CD (BF)	+000.6 μA	<05.00 mA
PA-NAT EF (BF)	+000.6 μA	<05.00 mA
PA-NAT GH (BF)	+000.6 μA	<05.00 mA
PA-NAT IK (BF)	+000.6 μA	<05.00 mA

19 Characteristic Values

Please refer to chapter 1.2 on page 7 to check as to which of the following measurements is required for the relevant regulation

Measured Quantity	Measuring Range/ Nominal Range of Use	Resolu- tion	Nominal Voltage U_N	Open- Circuit Voltage U_0	Nominal Current I_N	Short- Circuit Current I_K	Internal Resis- tance R_I	Reference Resistance R_{REF}	Measuring Uncertainty ⁸	Intrinsic Uncertainty ⁸	Overload Value	Capacity Time
Device Protective Conductor Resis- tance R_{PE}	0.000 ... 2.100 Ω	1 m Ω	—	4.5 ... 9 V DC	—	> 200 mA DC	—	—	$\pm(5\% \text{ rdg.} + 10 \text{ digits})$ > 10 d	$\pm(2.5\% \text{ rdg.} + 5 \text{ digits})$ > 10 digits	253 V	cont.
	2.11 ... 31.00 Ω	10 m Ω	—	< 6 V AC	—	> 10 A AC ⁴ > 5 s	—	—			no protection ⁵	
	0.000 ... 2.100 Ω	1 m Ω	—	< 6 V AC	—	> 10 A AC ⁴ > 5 s	—	—				
Insulation Resistance R_{INS}	0.050 ... 1.500 M Ω	1 k Ω	50 ... 500 V DC	$1.0 \cdot U_N \dots$ $1.5 \cdot U_N$	> 1mA	< 10 mA	—	—	$\pm(5\% \text{ rdg.} + 10 \text{ digits})$	$\pm(2.5\% \text{ rdg.} + 5 \text{ digits})$ > 10 digits	253 V	cont.
	1.01 ... 10.00 M Ω	10 k Ω							$\pm(5\% \text{ rdg.} + 10 \text{ digits})$	$\pm(2.5\% \text{ rdg.} + 5 \text{ digits})$ > 10 digits		
	10.1 ... 310.0 M Ω	100 k Ω							$\pm(10\% \text{ rdg.} + 10 \text{ digits})$	$\pm(10\% \text{ rdg.} + 10 \text{ digits})$		
Equivalent Leakage Current I_{EL}	0.00 ... 21.00 mA	10 μ A	—	230 V \sim - 20/ + 10 %	—	< 3.5 mA	> 72 k Ω	2 k Ω	$\pm(5\% \text{ rdg.} + 10 \text{ digits})$	$\pm(2.5\% \text{ rdg.} + 5 \text{ digits})$ > 10 digits	253 V	cont.
	20.1 ... 120.0 mA	100 μ A	—	230 V \sim - 20/ + 10 %	—	< 3.5 mA	> 72 k Ω	2 k Ω	$\pm(5\% \text{ rdg.} + 10 \text{ digits})$	$\pm(2.5\% \text{ rdg.} + 5 \text{ digits})$ > 10 digits	253 V	cont.
Contact Current (Absence of Voltage) I_{probe}	0 ... 3.500 mA	1 μ A	—	—	—	—	2 k Ω	—	$\pm(5\% \text{ rdg.} + 10 \text{ digits})$	$\pm(2.5\% \text{ rdg.} + 5 \text{ digits})$ > 10 digits	253 V	cont. ₂
Residual Current I_{RC} between L and N	0.000 ... 3.100 mA \sim 3.00 ... 31.00 mA \sim	1 μ A 10 μ A	—	—	—	—	—	—	$\pm(10\% \text{ rdg.} + 10 \text{ digits})$ > 10 digits	$\pm(5\% \text{ rdg.} + 5 \text{ digits})$ > 10 digits	1	1
Equivalent Device and/or Patient Leakage Current I_{EDL} and/or I_{EPL}	0.0 ... 310.0 μ A	0.1 μ A	—	230 V \sim - 20/ + 10 %	—	< 3.5 mA	> 72 k Ω	1 k Ω $\pm 50 \Omega$	$\pm(5\% \text{ rdg.} + 10 \text{ digits})$	$\pm(2.5\% \text{ rdg.} + 5 \text{ digits})$ > 10 digits	253 V	cont. _{1,3}
	0.000 ... 2.100 mA	1 μ A										
	2.101 ... 21.00 mA	10 μ A										
	20.1 ... 120.0 mA	100 μ A										
Leakage Current I_L ²	0.0 ... 310.0 μ A	100 nA	110 % of highest line voltage ⁶	—	—	—	1 k Ω	—	$\pm(5\% \text{ rdg.} + 10 \text{ digits})$	$\pm(2.5\% \text{ rdg.} + 5 \text{ digit})$ > 10 digit	253 V	cont. _{1,3}
All Leakage Current I_L ⁷	0.210 ... 3.600 mA	1 μ A	110 % of highest line voltage ⁶	—	—	—	1 k Ω	—	$\pm(5\% \text{ rdg.} + 10 \text{ digits})$	$\pm(2.5\% \text{ rdg.} + 5 \text{ digit})$ > 10 digit	253 V	cont. _{1,3}
	3.10 ... > 15.00 mA ⁹	10 μ A										

¹ As of 25 mA: shutdown by residual current measurement within 100 ms

² Exception earth leakage current: only 0.000 ... 3.100 mA

³ Measuring circuit is highly resistive, indication at display

⁴ Measurement with AC test current (Feature G00 or G01) is not possible at the sockets (1 through 3).

Feature G01 or **SECULIFE ST HV**: > 25 A; Short-circuit current is less than 25 A if the SC5 special cable is used.

⁵ Test duration max. 40 s, protection against overheating: measurement cannot be restarted until a waiting period of 1 minute has elapsed.

⁶ Calculated value

⁷ AC and DC are measured for patient leakage current and patient auxiliary current.

⁸ The data are only valid for the values displayed at the test instrument. Data which are transmitted via the RS232 interface may deviate.

⁹ only applies to earth leakage current or mains at application part

Key: of rdg. = of reading (measured value), D = digit

Function	Measured Quantity	Measuring Range / Nominal Range of Use	Resolution		Open-Circuit Voltage U_0	Short-Circuit Current I_K	Internal Resistance R_i		Measuring Uncertainty ⁸	Intrinsic Uncertainty ⁸	Overload Capacity Value	Duration	
Functions Test	Nominal Voltage U_{LN}	103,5 V ... 126,5 V 207,0 ... 253,0 V ~	0.1 V		—	—	—		—	$\pm(2.5\%rdg.+5\text{ digits})$	253 V	cont.	
	Load Current I_a	0 ... 16.00 A RMS	10 mA		—	—	—		—	$\pm(2.5\%rdg.+5\text{ digits})$	20 A	10 min	
	Active Power P	0 ... 3700 W ¹⁰	1 W		—	—	—		—	$\pm(5\%rdg.+10\text{ digits})$ > 20 digits	253 V	cont.	
	Apparent Power AP	0 ... 4000 VA	1 VA	Calculated Value $U_{LN} \cdot I_V$							$\pm(5\%rdg.+10\text{ digits})$ > 20 digits	20 A	10 min
	Power Factor PF, sinusoidal: $\cos \varphi$	0.00 ... 1.00	0.01	Calculated Value P / AP, Display > 10 W							$\pm(10\%rdg.+5\text{ digits})$		
	Residual Current ΔI between L and N	0.00 ... 31.00 mA ~	10 μ A		—	—	—		$\pm(10\%rdg.+10\text{ d})$ > 10 digits	$\pm(5\%rdg.+5\text{ digits})$	1	1	
$U_{AC/DC}$	Voltage	0 ... 253.0 V =, ~ and ≈	0.1 V		—	—	—		$\pm(5\%rdg.+10\text{ d})$	$\pm(2.5\%rdg.+5\text{ digits})$ > 10 digits	253 V	cont.	
U_{Probe}	Probe Voltage	0 ... 253.0 V =, ~ and ≈	0.1 V		—	—	—		—	$\pm(2.5\%rdg.+5\text{ digits})$ > 10 digits	253 V	cont.	
R	Resistance	0 ... 150.0 k Ω	100 Ω		< 20 V –	1.1 mA	—		—	$\pm(1\%rdg.+3\text{ digits})$	253 V	cont.	
I_{CLIP}	Current via Clip-On Current-Voltage Converter WZ12C	0.000 ... 10.00 A ~	1 mA		—	—	1.5 M Ω		—	$\pm(3\%rdg.+10\text{ digits})$ > 10 digits	253 V	cont.	
		0 ... 100 A ~	1 A		—	—	1.5 M Ω		—	> 10 digits without clip	253 V	cont.	
Temp	Temperature with Pt100 / Pt1000 Sensor	- 200 ... - 50 °C	1 °C		< 20 V –	1.1 mA	—		—	$\pm(2\%rdg.+1\text{ }^\circ\text{C})$	10 V	cont.	
		- 50.1 ... + 300.0 °C	0.1 °C					—	$\pm(1\%rdg.+1\text{ }^\circ\text{C})$	10 V	cont.		
		+300 ... +850 °C	1 °C					—	$\pm(2\%rdg.+1\text{ }^\circ\text{C})$	10 V	cont.		

¹⁰ Measured value P and calculated value S are compared, and the smaller value is displayed.

Reference Ranges

Line Voltage 115 / 230 V $\pm 0.2\%$
Line Frequency 50/60 Hz $\pm 0.1\%$
Waveshape sine (deviation between effective and rectified value < 0.5%)
Ambient Temperature +23 °C ± 2 K
Atmospheric Humidity 50% relative $\pm 5\%$
Load Resistors linear

Nominal Ranges of Use

Line Voltage 103.5 V ... 126.5 V or 207 V ... 253 V
Line Frequency 50 Hz or 60 Hz
Line Voltage Waveshape sine
Temperature 0 °C ... + 50 °C

Influencing Quantities and Influence Error

Influencing Quantity / Sphere of influence	Designation per DIN VDE 0404	Influence Error ± ... % of Measured Value
Position Change	E1	—
Change in Test Setup Supply Power	E2	2.5
Temperature Fluctuation	E3	Specified influence error applies per 10 K change in temperature:
0 ... 21 °C and 25 ... 40 °C		1 in case of PE measurement 0.5 for all other measuring ranges
Current at Device Under Test	E4	2.5
Low-Frequency Magnetic Fields	E5	2.5
Impedance at Device Under Test	E6	2.5
Capacitance, Insulation Measurement	E7	2.5
Waveshape of Measured Current	E8	2 for capacitive load (for equivalent leakage current)
49 ... 51 Hz		1 (for contact current)
45 ... 100 Hz		2.5 for all other measuring ranges

Ambient Conditions

Storage Temperature	– 20 °C ... + 60 °C
Operating Temperature	– 10 °C ... + 50 °C
Accuracy Range	0 °C ... + 50 °C
Relative Humidity	max. 75%, no condensation allowed
Elevation	max. 2000 m
Deployment	indoors, outdoors: only under specified ambient conditions

Power Supply

Line Voltage	103.5 V ... 126.5 V or 207 V ... 253 V
Line Frequency	50 Hz or 60 Hz
Power Consumption	approx. 30 VA
for 10 A test current	approx. 95 VA, test duration max. 70 s
for 25 A test current	approx. 180 VA, test duration max. 70 s
for function test	continuous max. 3600 VA, power is conducted through the instrument only, switching capacity ≤ 16 A

RS 232 Data Interface

Type	RS 232C, serial, per DIN 19241
Format	9600, N, 8, 1
Connector	9-pin subminiature socket connector

Electrical Safety

Safety Class	I per IEC 61010-1/EN 61010-1/VDE 0411-1
Nominal Voltage	115/230 V
Test Voltage	3.7 kV, 50 Hz
Measuring Category	250 V CAT II (is not valid for the jacks 1, 2 and 3)
Contamination Level	2
Safety Shutdown	for residual current at device under test > 25 mA, disconnecting time < 100 ms probe current > 10 mA, < 1 ms

Electromagnetic Compatibility

Product standard DIN EN 61326-1

Interference emission	Test Value	Class
EN 55011		B
Interference immunity	Test Value	Evaluation Criteria
EN 61000-4-2	Contact/Atmos. – 4 kV/8 kV	A
EN 61000-4-3	3 V/m or 1 V/m	A
EN 61000-4-4	1 kV	B
EN 61000-4-5	1 kV bzw. 2 kV	A
EN 61000-4-6	3 V/m	A
EN 61000-4-11	0.5/1/25 Periods	A
	250 Periods	C

Mechanical Design

Display	multiple dot matrix display, 128 x 128 pixels
Dimensions	test instruments without high-voltage module: LxWxH: 292 mm x 138 mm x 243 mm test instruments with high-voltage module: LxWxH: 292 mm x 138 mm x 300 mm
Weight	standard test instrument: approx. 4.5 kg instrument with HV test: approx. 5.24 kg instrument with 25 A PE test: approx. 5.5 kg instr. with 25 A PE & HV test: approx. 5.9 kg
Protection	housing: IP 40 terminals: IP 20 per DIN VDE 0470, part 1/EN 60529

Extract from table on the meaning of IP codes

IP XY (1 st digit X)	Protection against foreign object entry	IP XY (2 nd digit Y)	Protection against the penetration of water
0	not protected	0	not protected
1	≥ 50.0 mm Ø	1	vertically falling drops
2	≥ 12.5 mm Ø	2	vertically falling drops with enclosure tilted 15°
3	≥ 2.5 mm Ø	3	spraying water
4	≥ 1.0 mm Ø	4	splashing water

Service socket (20) – Terminal data

(Prerequisite: Feature B01)

Line Voltage 103.5 V ... 126.5 V or 207 V ... 253 V

Line Frequency 50 Hz or 60 Hz

Current output protected by building installation
(16 A; fed through to the mains plug)

High-Voltage Test

(Prerequisite: Feature F02 or **SECULIFE ST HV**)

Transducer

Nominal Voltage, AC	$U_{N..}$ adjustable	in 10 V steps in 100 V steps	0.5 ... 0.99 kV 1 ... 4.0 kV $((U_{N..} \cdot 1.5) \cdot 1.011) + 60$ V
Open-Circuit Voltage, DC	U_o		
Intrinsic Error, U_o	U_o		±1.5%
Nominal Current	per DIN VDE 0104		< 3.5 mA DC
Short-Circuit Current	discharge current		> 5 A at 6 kV
Resistance to Interference Voltage			none

Test Duration as long as START key is pressed (max. 60 sec.)

Measuring

Measuring Range	Display Range	Intrinsic Error, U_o
0 ... U_{omax}	0.000 ... > 10.00 kV DC	±1.5% rdg. + 2 digits

Maximum Test Voltage

SC I* DUTs 1.5 kV

SC II DUTs 4 kV

* devices with protective conductor terminal

20 RS 232 Interface

Jack RS232 is provided for the connection of the following instruments:

- (P)SI module (accessory),
which can be inserted into the lid of the tester
- PC
- Barcode scanner of the following type:
B3261 with RS232 interface (article number: GTZ3261000R0001)
Z720A with RS232 interface (article number: Z720A)

or RFID scanner of the following type:
Z751G with RS232 interface (article number: Z751G)

20.1 Transmission of Measurement Results to the (P)SI module

Test results – except for results from individual measurements and the function test – can be transmitted from the test instrument to the (P)SI module, where they can be stored and printed out in the form of measuring, test and statistics reports at any time.

20.2 PC Connection

Connection to an IBM compatible PC is also possible. The PC is connected to the interface at the test instrument, or to the interface port at a previously installed (P)SI module.

20.2.1 Software Evaluation of Measurement Results

Convenient software programs such as PC.doc-WORD/EXCEL, PC.doc-ACCESS or PS3 allow for easy preparation of measuring and test reports, as well as archiving of measured data.

20.2.2 Instrument Control via Interface Commands

All key functions included with the test instrument can be simulated with the help of interface protocols, and the following parameters can be queried:

- Type of measurement and measuring range
- Test setup
- Measurement sequence progress
- Detailed measuring results

20.3 Interface Definition and Protocol

The interface included with the test instrument is in compliance with the RS 232 standard.

Technical Data:

Baud Rate	9600 baud, permanently set
Character Length	8 bits
Parity	none
Stop Bits	1
Data Protocol	per DIN 19244 X_ON / X_OFF protocol

Connector Pin Assignments, 9-Pin Subminiature Socket Connector:

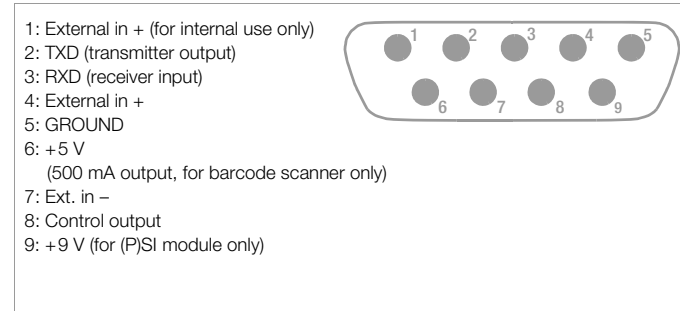

Note

A detailed description of the interface protocols is available from our Product Support, refer to chapter 24 for contact details.

21 Appendix

21.1 Evaluation of Measured Values for Individual Measurements as well as for Calculated Quantities

In order to assure that the limit values for the individual measurements are always observed, device measuring error must be taken into consideration.

The table in the appendix allows for calculation of the required minimum display value for each respective measurement which must appear at the instrument in consideration of measuring error (under nominal conditions of use), in order to assure that the required limit value is not fallen short of (DIN VDE 0413, part 1). Intermediate values can be interpolated.

Measuring Error for Test Sequences

The test instrument takes respective measuring error into consideration during automatic test sequences, and corrected results are entered into the test report, as long as this function has been activated in the setup menu under "include service error".

Omitting the Protective Conductor Test in the Case of Fully Insulated Devices

You are testing a fully insulated safety class I device (e. g. screen, submersible pump, etc.), which is not equipped with an external protective conductor contact.

The decision as to the necessity of a protective conductor test in this case is to be taken by a qualified electrician who should also assume responsibility. You can omit the protective conductor test by pressing the key  as soon as the following instruction is shown: „Please connect the probe with the protective conductor of the DUT“.

Tables for the calculation of minimum display values for insulation resistance and maximum display values for protective conductor resistance, equivalent leakage current, probe current and residual current in consideration of device measuring error:

$R_{INS} M\Omega$		$R_{PE} \Omega$	
Limit Value	Minimum Display Value	Limit Value	Maximum Display Value
0.100	0.115	0.100	0.085
0.250	0.273	0.200	0.180
0.500	0.535	0.300	0.275
1.000	1.060	0.400	0.370
2.000	2.200	0.500	0.465

5.000	5.350	0.600	0.560
7.000	7.450	0.700	0.655
10.00	10.60 or 12.5 ¹⁾	0.800	0.750
20.00	23.00	0.900	0.845
75.00	83.50	1.000	0.940
		1.100	1.035

¹⁾ Depending upon resolution

$I_{EL} mA$		$I_{probe} mA$		$\Delta I mA$	
Limit Value	Maximum Display Value	Limit Value	Maximum Display Value	Limit Value	Maximum Display Value
1.00	0.85	0.100	0.085	0.25	0.12
3.50	3.23	0.250	0.227	0.50	0.35
7.00	6.55	0.500	0.465	1.00	0.80
10.00	9.40	1.000	0.940	2.00	1.70
15.00	14.15	2.000	1.890	3.50	3.05
20.00	18.90	3.500	3.315	5.00	4.40
				7.00	6.20
				10.00	8.90
				15.00	13.40
				20.00	17.90
				25.00	22.40

21.2 Evaluation of Measured Values during Equivalent Leakage Current Measurement (Automatic Test Sequence According to Standard)

During equivalent leakage current measurement, L and N are interconnected whereupon a test voltage of 230 V is applied between LN and PE and the leakage current is measured. Thus the most adverse case (N interrupted) is being tested.

As a rule, this results in at least double the value of the direct leakage current measurement (since all discharge capacitors are placed in parallel).

If frequency converters are used in addition to that, it is no longer possible to compare the measured values between direct leakage current and equivalent leakage current method. In this case, we recommend conducting individual measurements in accordance with the residual current method.

21.3 Index

A	Electrical Safety	62	
Acst Sig, Meas	Electromagnetic Compatibility	62	
Acst Sig, Seq	Equivalent (Device) Leakage Current	7	
Alternating / Direct Voltage UAC/DC	Equivalent Device Leakage Current ...	7, 22, 23	
Ambient Conditions	Equivalent Leakage Current	7	
App prt	Equivalent Patient Leakage Current ..	7, 22, 23	
Auto (Test) Method	Extension Cables	46	
Auto Class PSI			
Auto R-PE	F		
Automode	Finger Contact	12	
Autostore	Firmwareversion	2	
	First Measured Values	39	
	Frequency Response	26	
	Function Test	34	
C			
Calibration	H		
Classification	High-Voltage Test	7, 17, 24	
Combined Testing	HV Test	39	
Configuring Device Parameters	HV Test Duration	39	
Configuring Measurement Parameters			
Connecting the Device Under Test	I		
Contact Current	ILC	27	
Contact Problems	Illumination	18	
Contrast Adjustment	Incl. Service Error	18	
Cross section	Influencing Quantities and Influence Error ..	62	
	Insulation Resistance	7, 20	
	Insulation Resistance Limit Values	21	
	Interface	64	
	IT Network	18	
D	L		
Data Security	Leakage Current from applied part	7	
Device Leakage Current	Limit Values... (menu - selector switch Setup	position)	18
Devices with Internal Power Supply			
Differential Current Measurement			
Direct Print-Out			
E			
Earth Fault			
Earth Leakage Current			

M	Mains Connection Errors	12	
Mains Polarity Reversal	Mains Power Outlet	11	
Mains Wait	Mains Wait	18, 39	
Manual Sequence	Measurements with Accessories	32	
Measurements with Accessories	Measuring Error	65	
Measuring Error	Measuring Protective Conductor Resistance	19	
Measuring Protective Conductor Resistance	Mechanical Design	63	
Mechanical Design	Multimeter Functions	30	
Multimeter Functions			
	N		
	No I-HL for SC I	39	
	Nominal Ranges of Use	61	
	O		
	Online Help	13	
	Options		
	EL1 adapter	46	
	List of Possible Options and Standard Ty-	pes	8
	P		
	Patient Auxiliary Current	7, 27, 39	
	Patient Leakage Current	7, 27	
	Periodic Testing	6	
	Power Supply	62	
	Probe Voltage Uprobe	30	
	Protective Conductor Resistance	7	
	R		
	Reference Ranges	61	

Reference Voltage	18, 54, 56	Test Current	7
Reports... (menu - selector switch Setup position)	18	Test Sequence... (menu - selector switch Setup position)	18
Residual Current	7, 27	Test Time	18
Residual Current Method	7	Testing after Repairs	6
Resistance R	31	total patient leakage current	7
R-INS AWT-SL	39	Type B Application Parts	15
R-INS LN-SL	39	Type BF Application Parts	15
R-PE AC > 10 A	39	Type CF Application Parts	15
R-PE with clip	38, 39		

S

Safety Class I Devices	15
Safety Class II Devices	15
Safety Class III Devices	15
Safety Extra Low Voltage	15, 31
Saving Settings to Memory	14
SC I I I UV	39
SECULOAD	30
SECUSTORE	3, 18, 59
Select template	18
Service socket	
connection	3
Terminal data	63
Service... (menu - selector switch Setup position)	18
Setting Limit Values	14
Setting of Time and Date	18
Short-Circuit Test	35
Single Fault	18
Single Fault Conditions	7
Socket Adapter	39
Switching loads on and on	9

T

Test Conditions	56
-----------------------	----

V

Visual Inspection	39
-------------------------	----

W

Welding equipment	30
-------------------------	----

Z

Zero Balancing	20, 33
----------------------	--------

22 Maintenance - Recalibration

22.1 Housing Maintenance

No special maintenance is required for the housing. Keep outside surfaces clean. Use a slightly dampened cloth for cleaning. Avoid the use of cleansers, abrasives or solvents.

22.2 Recalibration

The respective measuring task and the stress to which your measuring instrument is subjected affect the ageing of the components and may result in deviations from the guaranteed accuracy.

If high measuring accuracy is required and the instrument is frequently used in field applications, combined with transport stress and great temperature fluctuations, we recommend a relatively short calibration interval of 1 year. If your measuring instrument is mainly used in the laboratory and indoors without being exposed to any major climatic or mechanical stress, a calibration interval of 2-3 years is usually sufficient.

During recalibration* in an accredited calibration laboratory (DIN EN ISO/IEC 17025) the deviations of your instrument in relation to traceable standards are measured and documented. The deviations determined in the process are used for correction of the readings during subsequent application.

We are pleased to perform DAkkS or factory calibrations for you in our calibration laboratory. Please visit our website at www.gossenmetrawatt.com (→ Company → DAkkS Calibration Center or → FAQs → Calibration questions and answers).

By having your measuring instrument calibrated regularly, you fulfill the requirements of a quality management system per DIN EN ISO 9001.

Standards DIN VDE 0701-0702 and IEC 63353 (VDE 0751) stipulate that only measuring instruments which are regularly tested and calibrated may be used for testing.

* Verification of specifications or adjustment services are not part of the calibration. For products from our factory, however, any necessary adjustment is frequently performed and the observance of the relevant specification is confirmed.

22.3 Safety Checks

Check the safety of your test instrument on a regular basis. We recommend the same test intervals as for recalibration.

The SECUTEST... is designed as a totally insulated instrument in accordance with standards IEC 61010 and VDE 0404. The protective conductor is only used for measurement purposes and is therefore not accessible in idle state. A protective conductor test at the test socket can be performed as follows:

- ⇒ Connect the SECUTEST... to a multiple distribution box.
- ⇒ Conduct a contact current measurement for permanently installed DUTs (the test socket may not be connected to any load).
- ⇒ Measure the protective conductor resistance between the neighbouring socket of the multiple distribution box and the test socket.
- ⇒ The measured value may not exceed 0.3 Ω.

Insulation resistance between LN and PE in the SECUTEST... equals approx. 150 kΩ for metrological reasons.

This must be taken into account when performing the safety checks, i.e. the protective conductor current measurement must produce a value below 3.5 mA, instead of insulation resistance measurement (if the equivalent leakage current measurement method has been chosen, the value must remain below 7 mA).

Apart from this, the SECUTEST... features 3 exposed conductive parts for which contact current measurement must produce a value below 0.5 mA:

- RS232 interface
- metallized start key
- protective conductor clip at the test socket.

22.4 Device Return and Environmentally Compatible Disposal

The test instrument is a category 9 product (monitoring and control instrument) in accordance with ElektroG (German Electrical and Electronic Device Law). This device is not subject to the RoHS directive.

We identify our electrical and electronic devices (as of August 2005) in accordance with WEEE 2002/96/EG and ElektroG with the symbol shown to the right per DIN EN 50419 .

These devices may not be disposed with the trash.

Please contact our service department regarding the return of old devices, address see chapter 23.



23 Repair and Replacement Parts Service Calibration Center* and Rental Instrument Service

If service is required please contact:

GMC-I Service GmbH

Service Center

Thomas-Mann-Strasse 20

90471 Nürnberg · Germany

Phone +49 911 817718-0

Fax +49 911 817718-253

E-Mail service@gossenmetrawatt.com

www.gmci-service.com

This address is only valid in Germany.

Please contact our representatives or subsidiaries for service in other countries.

* DAKkS Calibration Laboratory for Electrical Quantities

D-K-15080-01-01 accredited per DIN EN ISO/IEC 17025:2005

Accredited measured quantities: direct voltage, direct current values, DC resistance, alternating voltage, alternating current values, AC active power, AC apparent power, DC power, capacitance, frequency and temperature

Competent Partner

GMC-I Messtechnik GmbH is certified in accordance with DIN EN ISO 9001:2008.

Our DAKkS calibration laboratory is accredited by the Deutsche Akkreditierungsstelle GmbH (National accreditation body for the Republic of Germany) in accordance with DIN EN ISO/IEC 17025:2005 under registration number D-K-15080-01-01.

We offer a complete range of expertise in the field of metrology: from **test reports** and **proprietary calibration certificates** right on up to **DAKkS calibration certificates**.

Our spectrum of offerings is rounded out with free **test equipment management**.

An **on-site DAKkS calibration station** is an integral part of our service department. If errors are discovered during calibration, our specialized personnel are capable of completing repairs using original replacement parts.

As a full service calibration laboratory, we can calibrate instruments from other manufacturers as well.

24 Product Support

If support is required please contact:

GMC-I Messtechnik GmbH

Product Support Hotline

Phone +49 911 8602-0

Fax +49 911 8602-709

E-Mail support@gossenmetrawatt.com

Edited in Germany • Subject to change without notice • A pdf version is available on the internet

 **GOSSEN METRAWATT**
GMC-I Messtechnik GmbH
Südwestpark 15
90449 Nürnberg • Germany

Phone +49 911 8602-111
Fax +49 911 8602-777
E-Mail info@seculife.eu
www.seculife.eu